

Hawthorn Hill

Luxury Detailing



PRICING CATALOGUE

TOWEL WARMERS • BASIN STANDS • GRAB RAILS • ROBE WARMERS • MIRRORS

Hawthorn Hill

Luxury Detailing

Hawthorn Hill offers luxury detailing throughout the bathroom with its range of hand-crafted brassware.

Handmade in England from premium brass, each piece is carefully engineered, assembled and finished by craftspeople who understand artisan manufacture.

Hawthorn Hill fittings are definitive luxury detailing in any bathroom. These beautiful pieces will be desired for their functionality and aesthetics today, and treasured tomorrow.

A bespoke service is available. We can adapt some models using your custom specification to suit the particular needs of a project or we can help you create something unique.

Index

OUR OFFERING 2-3

STYLES 4

FINISHES 5

CONTEMPORARY

- Basin Stands
 - for Benchtops 30
 - for Soho Basins 32
 - for Lonsdale Basins 34
 - for Paddington Basins 34
- Grab Rails 39
- Robe Warmers 36
- Towel Bars 36
- Towel Warmers 38

TRADITIONAL

- Basin Stands
 - for Benchtops 42
 - for Rockwell Basins 44
- Grab Rails 51
- Robe Warmers 50
- Towel Bars 50
- Towel Warmers 49

ORNATE

- Basin Stands
 - for Paris Basins 54
 - for Benchtops 56
- Grab Rails 61
- Robe Warmers 60
- Towel Bars 60
- Towel Warmers 58

MIRRORS

- Fixed Wall Mirrors 64
- Shaving Cabinet Mirrors 64
- Classical Tilting Wall Mirrors 65
- Deco Tilting Wall Mirrors 69
- Vanity Mirrors 66

BATHROOM ACCESSORIES

- Bathroom Stands 67
- Towel Racks 67
- Bath Racks 68
- Deco Collection 69

CUSTOM ORDERING 72

TECHNICAL 76

Hawthorn Hill

Luxury Detailing



Hawthorn Hill

Luxury Detailing

OUR OFFERING



Towel Warmers

Designed and hand-crafted in England, Hawthorn Hill towel warmers represent the finest in workmanship, creating feature heritage pieces for the most prestigious homes.

Available in a selection of quality finishes, these heated towel rails will impart a wealth of style and functionality. Each of these 240V electric towel rails come with concealed mounts for a seamless installation and are supplied with a 6m dry-line electrical cable. They are IP55 rating for compliant use in Australian and New Zealand bathrooms.



Basin Stands

Hawthorn Hill offers basin stands designed and hand-crafted in England to fit under benchtops or our selection of basins. We offer a range of standard sizes in Ornate, Traditional or Contemporary styles with stepped, ball or pointed feet. These have been paired with the best quality English made basins we can find; from The Water Monopoly. For additional storage of towels or baskets you may upgrade to a tubular shelf beneath your stand.

For a truly personal touch to your bathroom or dressing room, consider a made-to-order stand. We can customise to any length, height and depth you require.

Accessible bathrooms: We can offer custom design solutions for accessible bathrooms too. Just ask one of our team.



Grab Rails

There is a strong likelihood that at some time in our life our mobility - or that of a friend or relative - will be compromised. In the event this disability is permanent, affecting ambulation and transfers within the home, support rails become a necessity.

Hawthorn Hill's Grab Rail Collection now delivers the opportunity to add this support, without compromising interior aesthetics. They are available as either straight rails or L-shaped left or right-handed designs, in Contemporary, Traditional and Ornate styling.

Hawthorn Hill grab rails are tested for compliance with the Australasian Standard for Access and Disability, ready for installation into Australian and New Zealand homes.

They are moisture resistant, allowing them to be placed in showers and over baths, where they are most needed. They can be earthed to reduce static and electricity build-up, a requirement when fitted in wet areas.

Hawthorn Hill

Luxury Detailing

OUR OFFERING



Mirrors

With fully customisable sizes and a range of finishes these premium quality mirrors can be a true reflection of you.

British-designed and manufactured in brass, Hawthorn Hill mirrors are available in a range of polished and satin finishes; a beautiful choice for any bathroom, dressing room or bedroom.

Framed wall mirrors are available fixed or tilting in Classic or Deco styles. Tilting mirrors and vanity mirrors great for people of different heights using same bathroom.

Shaving Cabinet Mirror

We offer a shaving cabinet version of the fixed mirror that may be flush-mounted on the wall and have a custom joinery built in behind. We can provide these early on in the project to your joiner for fitting.



Vertical Robe Warmers

Following in the footsteps of the Hawthorn Hill towel warmers, the new vertical robe rails ensure luxuriously warm robes and towels while also allowing flexibility of installation in a bathroom with tight wall spaces. The brass hooks rotate to allow fine adjustment by the homeowner.

These robe warmers which are designed and hand-crafted in England are available in Ornate, Traditional and Contemporary styles and come as single vertically installed rails. The vertical bar is heated with a 240V dry-line cable. They are also IP55 rating for compliant use in Australian and New Zealand bathrooms.



Bath Stands & Accessories

Made from the highest quality brass, every Hawthorn Hill bathroom accessory is soldered, plated and polished by hand, which means you can be assured of the highest quality product.

The Hawthorn Hill bathroom stands are perfect for powder rooms and bathrooms where you require simple storage. They are also just the right height to sit beside the bath with a book, candle and glass of bubbles.

Each bath stand is designed and hand-crafted in England in two sizes. They feature 19mm lathe turned tubular legs, toughened glass shelves, guard rails on the top shelf, and adjustable stepped feet to accommodate uneven floors.

Hawthorn Hill

Luxury Detailing

STYLES



CONTEMPORARY
CORNER



TRADITIONAL
CORNER



ORNATE
CORNER



CONTEMPORARY
JOINT



TRADITIONAL
JOINT



ORNATE
JOINT



STEPPED FOOT



BALL FOOT



POINTED FOOT

Hawthorn Hill

Luxury Detailing

METAL FINISHES



CHROME - CP



NICKEL - NI



PEWTER - PF



SATIN BRASS - SB



POLISHED BRASS - BR



GOLD - IG



ANTIQUÉ BRASS - AB



BRONZE - BZ



GUN METAL - GM



PROJECT
GALLERY

GOLDEN LIGHT

Arent&Pyke have beautifully executed this ensuite with natural light adjustable with the timber shutters, to allow privacy for the intimacy of bathing. The Hawthorn Hill towel rack provides towels within arms reach.

DESIGN: ARENT&PYKE
PHOTOGRAPHY: ANSON SMART





TOWEL RACK
HHCA600-850N



BISCAYNE

Kate Walker used our custom design service to create the vanity of her dreams for the Biscayne master ensuite. Hawthorn Hill custom-sized polished brass basin stand was designed to the width of the room, with gorgeous detailing of traditional ball joints and ball feet beneath the Amazonia stone benchtop.

DESIGN: KWD
PHOTOGRAPHY: ARMELLE HABIB



COVER: DOUBLE BASIN STAND:
HHTDF-CUSTOM-TB BR

BISCAYNE

The Hawthorn Hill wall mounted towel warmer above the inset bath provides enough hanging space for two towels.

DESIGN: KWD
PHOTOGRAPHY: ARMELE HABIB



WALL TOWEL WARMER:
HHTW-675-675-3-E BR





BISCAYNE

The powder room is sheer frivolity and fun with Gucci Heron wallpaper. Featuring The Water Monopoly curved Paris basin on a Hawthorn Hill brass stand alongside pretty accessories and tapware by Perrin & Rowe, the interior echoes the whimsical flamboyance of regency style Floridian homes.

DESIGN: KWD
PHOTOGRAPHY: ARMELLE HABIB



BASIN STAND:
HHRC-PARIS-1020-RP BR

MATCHING BASIN:
WM-PARIS-1020-BASIN3



PONSONBY VILLA

Abbey Lang loves the raw brass and patina of our brass towel warmers and basin stands paired alongside Rockwell taps.

The soft, rich palette of Moroccan zellige tiles, Tundra Grey stone and raw brassware celebrates natural materiality, while the Shaker-style joinery embraces the villa's heritage.

DESIGN: ABBEY LANG
PHOTOGRAPHY: SAMUEL HARNETT



BASIN STAND:
WM-RW-750BS-WH

LEFT: WALL TOWEL WARMER:
HHTW-675-675-3-E BR

EPSOM BUNGALOW

A hundred-year-old 'transition villa' has been sensitively updated to include a stunning guest bathroom with twin wash stations—each with a Hawthorn Hill round tilting mirror, Perrin & Rowe tap and basin set above a Hawthorn Hill traditional chrome basin stand with ball feet. The two single basin stands are joined by a single benchtop, and a bank of drawers in between provides ample storage for all bathroom necessities.

PHOTOGRAPHY: MARK SCOWEN



WALL TOWEL WARMER:
HHTW-675-675-3-E CP



TILTING WALL MIRRORS:
HH-MIRRORROUND CP

VANITY MIRROR:
HH-MIRRORTABLE-S CP

TWIN BASIN STANDS:
HHTF-750-TB

IN RESIDENCE GUEST BATHROOM

This guest bathroom is a showcase of quality fixtures, with Hawthorn Hill grab rail beside Perrin & Rowe wall hung pan and Aquadomo flush plate, with a Hawthorn Hill tilting round mirror above Lonsdale basin on basin stand with shelf. Perrin & Rowe taps and accessories complete the space.

PHOTOGRAPHY: MARK SCOWEN



L SHAPE GRAB RAIL:
HHCL-GRAB450-450



TILTING WALL MIRROR:
HH-MIRRORROUND NI

LONSDALE BASIN STAND:
HHCS-LONS-550SF-CS NI

MATCHING BASIN
WM-LONS-BASIN-550-3

CAPE SCHANCK

The spacious, modern Master Ensuite features traditional 'his & hers' brass Hawthorn Hill vanities, Perrin & Rowe tapware, and a Victoria & Albert Amiata bath, all set on the gorgeous polished concrete floor that runs throughout the home.

The guest bathrooms are a simplified version of the master, each with a single Hawthorn Hill basin stand and each with their own sweet colour scheme.

ARCHITECT: IAIN DYKES
PHOTOGRAPHY: PATRICK REDMOND



BASIN STANDS
HHTF-750-RP SB



FINCH STREET

This light-filled, modern bathroom is a joyful interplay between tiled surfaces, The Water Monopoly Rockwell bath and Italia Grigio terrazzo floor tiles with marble chip aggregate.

The Water Monopoly Rockwell basin on a Hawthorn Hill stand in polished brass with black ball feet draws your attention to the eye-catching stone once more, while an entire wall of cabinetry opposite does the heavy lifting regarding storage.

ARCHITECTURE: LSA
PHOTOGRAPHY: PATRICK REDMOND

BASIN STAND:
HHTS-RW-610-TB

BLACK BALL FEET:
WM-RW-BSTAND-FEET-BK

MATCHING BASIN:
WM-RW-BASIN-610-3-WH



SPEARGRASS HOUSE

Designed by New Zealand architects Sumich Chaplin, with interiors by Sydney-based Arent & Pyke, this stunning project is a collaboration that has won acclaim on both sides of the Tasman.

Each of the bathrooms in the home features walls stacked in travertine, glazed tiles, and marble. The layers of texture convey a soft sensuality enhanced by the gentle flicker of sunlight upon their surfaces. To add warmth and functionality, Hawthorn Hill arched and wall towel warmers were included in each of the bathrooms.

INTERIOR DESIGN, DECORATION & STYLING: ARENT & PYKE
ARCHITECTURE: SUMICH CHAPLIN PHOTOGRAPHY: ANSON SMART
PHOTO STYLING: JACK MILENKOVIC, ATELIER LAB





WALL TOWEL WARMER:
HHCW-675-675-3-E NI



CONTEMPORARY
COLLECTION



CONTEMPORARY BASIN STANDS WITH STEPPED FEET







STYLE	CODE	DESCRIPTION	DIMENSIONS			PRICING IN EACH FINISH (INCL. GST)				
			H HEIGHT (MM) OVERALL	W WIDTH (MM) CENTRES	D DEPTH(MM) CENTRES	CHROME / POLISHED BRASS/SATIN BRASS	NICKEL	PEWTER	ANTIQUE BRASS/ BRONZE /GUN METAL	GOLD
						CP / BR / SB	NI	PF	AB / BZ / GM	IG
	HHCF-750-CS	CONTEMPORARY STEPPED - Single 4 leg freestanding basin stand.	880	750	480	\$4,290	\$4,670	\$4,860	\$5,800	\$6,175
	HHCD-1500-CS	CONTEMPORARY STEPPED - Double 3 leg wall mounted basin stand.	880	1500	540	\$3,800	\$4,115	\$3,715	\$4,405	\$4,680
	HHCDF-1500-CS	CONTEMPORARY STEPPED - Double 6 leg freestanding basin stand with shelf	880	1500	480	\$8,225	\$8,980	\$8,140	\$9,785	\$10,445

Note: Basins, benchtops, tapware and bottletraps excluded from list price and sold separately.

This document supersedes all previous pricelists and is subject to change without notice. All pricing is in NZD New Zealand Dollars. RRP Pricing incl. GST. This pricelist is published & distributed by In Residence, New Zealand. E+OE. Prices issued on 13 May 2026. V038INTD-HH



CONTEMPORARY BASIN STANDS WITH STEPPED FEET







STYLE	CODE	DESCRIPTION	DIMENSIONS			PRICING IN EACH FINISH (INCL. GST)				
			H HEIGHT (MM) OVERALL	W WIDTH (MM) CENTRES	D DEPTH(MM) CENTRES	CHROME / POLISHED BRASS/SATIN BRASS	NICKEL	PEWTER	ANTIQUE BRASS/ BRONZE /GUN METAL	GOLD
						CP / BR / SB	NI	PF	AB / BZ / GM	IG
	HHCF-750SF-CS	CONTEMPORARY STEPPED - Single 4 leg freestanding basin stand with shelf	880	750	480	\$7,695	\$8,785	\$7,965	\$9,600	\$10,255
	HHCD-1500SF-CS	CONTEMPORARY STEPPED - Double 3 leg wall mounted basin stand with shelf.	880	1500	540	\$7,345	\$8,405	\$7,615	\$9,150	\$9,765
	HHCDF-1500SF-CS	CONTEMPORARY STEPPED - Double 6 leg freestanding basin stand with shelf	880	1500	480	\$13,880	\$15,825	\$14,365	\$17,365	\$18,565
	HH-ANGLE-520	HAWTHORN HILL - Basin stand top support angle. 520mm x 32mm x 32mm. 3mm thick.	32	520	32	\$280	\$310	\$280	\$340	\$365
	HH-ANGLE-1040	HAWTHORN HILL - Basin stand top support angle. 1040mm x 32mm x 32mm. 3mm thick.	32	1040	32	\$580	\$640	\$580	\$705	\$755
	HHC-PAPERHOLDER	HAWTHORN HILL - Toilet paper holder attachment for basin stand (install at time of basin stand installation) Suits Contemporary tube size	114	183	32	\$505	\$550	\$505	\$615	\$660

Note: Basins, benchtops, tapware and bottletraps excluded from list price and sold separately.

This document supersedes all previous pricelists and is subject to change without notice. All pricing is in AUD Australian Dollars. RRP Pricing incl. GST.
This pricelist is published & distributed by The English Tapware Company, Australia. E+OE. Prices issued on 13 May 2026. V038INTD-HH



CONTEMPORARY BASIN STANDS WITH STEPPED FEET







STYLE	CODE	DESCRIPTION	DIMENSIONS			PRICING IN EACH FINISH (INCL. GST)				
			H HEIGHT (MM) OVERALL	W WIDTH (MM) CENTRES	D DEPTH(MM) CENTRES	CHROME / POLISHED BRASS/SATIN BRASS	NICKEL	PEWTER	ANTIQUE BRASS/ BRONZE /GUN METAL	GOLD
						CP / BR / SB	NI	PF	AB / BZ / GM	IG
	HHCS-SOHO-450-CS	CONTEMPORARY STEPPED - Single 2 leg wall mounted basin stand. Basin sold separately - suits The Water Monopoly Soho 450mm basin WM-SOHO-450	745	380	340	\$2,180	\$2,340	\$2,110	\$2,470	\$2,615
	HHCS-SOHO-500-CS	CONTEMPORARY STEPPED - Single 2 leg wall mounted basin stand. Basin sold separately - suits The Water Monopoly Soho 500mm basin WM-SOHO-500	745	380	340	\$2,275	\$2,450	\$2,210	\$2,590	\$2,745
	HHCS-SOHO-600-CS	CONTEMPORARY STEPPED - Single 2 leg wall mounted basin stand. Basin sold separately - suits The Water Monopoly Soho 600mm basin WM-SOHO-600	745	475	440	\$2,350	\$2,535	\$2,285	\$2,680	\$2,840
	HHCS-SOHO-700-CS	CONTEMPORARY STEPPED - Single 2 leg wall mounted basin stand. Basin sold separately - suits The Water Monopoly Soho 700mm basin WM-SOHO-700	745	560	490	\$2,385	\$2,570	\$2,315	\$2,725	\$2,885
	HHCS-SOHO-1000-CS	CONTEMPORARY STEPPED - Single 2 leg wall mounted basin stand. Basin sold separately - suits The Water Monopoly Soho 1000mm basin WM-SOHO-1000	745	870	495	\$2,440	\$2,635	\$2,370	\$2,790	\$2,955
	HHCS-SOHO-1300-CS	CONTEMPORARY STEPPED - Single 2 leg wall mounted basin stand. Basin sold separately - suits The Water Monopoly Soho 1300mm basin WM-SOHO-1300	745	1120	450	\$2,615	\$2,830	\$2,550	\$3,005	\$3,190

Note: Basins, benchtops, tapware and bottletraps excluded from list price and sold separately.

This document supersedes all previous pricelists and is subject to change without notice. All pricing is in NZD New Zealand Dollars. RRP Pricing incl. GST. This pricelist is published & distributed by In Residence, New Zealand. E+OE. Prices issued on 13 May 2026. V038INTD-HH



CONTEMPORARY BASIN STANDS WITH STEPPED FEET





STYLE	CODE	DESCRIPTION	DIMENSIONS			PRICING IN EACH FINISH (INCL. GST)				
			H HEIGHT (MM) OVERALL	W WIDTH (MM) CENTRES	D DEPTH(MM) CENTRES	CHROME / POLISHED BRASS/SATIN BRASS	NICKEL	PEWTER	ANTIQUE BRASS/ BRONZE /GUN METAL	GOLD
						CP / BR / SB	NI	PF	AB / BZ / GM	IG
	HHCS-SOHO-450SF-CS	CONTEMPORARY STEPPED - Single 2 leg wall mounted basin stand with shelf. Basin sold separately - suits The Water Monopoly Soho 450mm basin WM-SOHO-450	745	360	230	\$3,335	\$3,745	\$3,380	\$4,020	\$4,275
	HHCS-SOHO-500SF-CS	CONTEMPORARY STEPPED - Single 2 leg wall mounted basin stand with shelf. Basin sold separately - suits The Water Monopoly Soho 500mm basin WM-SOHO-500	745	380	340	\$3,730	\$4,210	\$3,810	\$4,540	\$4,830
	HHCS-SOHO-600SF-CS	CONTEMPORARY STEPPED - Single 2 leg wall mounted basin stand with shelf. Basin sold separately - suits The Water Monopoly Soho 600mm basin WM-SOHO-600	745	475	440	\$3,850	\$4,355	\$3,935	\$4,695	\$4,995
	HHCS-SOHO-700SF-CS	CONTEMPORARY STEPPED - Single 2 leg wall mounted basin stand with shelf. Basin sold separately - suits The Water Monopoly Soho 700mm basin WM-SOHO-700	745	560	490	\$3,980	\$4,495	\$4,070	\$4,855	\$5,170
	HHCS-SOHO-1000SF-CS	CONTEMPORARY STEPPED - Single 2 leg wall mounted basin stand with shelf. Basin sold separately - suits The Water Monopoly Soho 1000mm basin WM-SOHO-1000	745	870	495	\$4,415	\$4,995	\$4,515	\$5,375	\$5,720
	HHCS-SOHO-1300SF-CS	CONTEMPORARY STEPPED - Single 2 leg wall mounted basin stand with shelf. Basin sold separately - suits The Water Monopoly Soho 1300mm basin WM-SOHO-1300	745	1120	450	\$4,615	\$5,220	\$4,720	\$5,625	\$5,990

Note: Basins, benchtops, tapware and bottletraps excluded from list price and sold separately.

This document supersedes all previous pricelists and is subject to change without notice. All pricing is in AUD Australian Dollars. RRP Pricing incl. GST. This pricelist is published & distributed by The English Tapware Company, Australia. E+OE. Prices issued on 13 May 2026. V038INTD-HH



CONTEMPORARY BASIN STANDS WITH STEPPED FEET





STYLE	CODE	DESCRIPTION	DIMENSIONS			PRICING IN EACH FINISH (INCL. GST)				
			H HEIGHT (MM) OVERALL	W WIDTH (MM) CENTRES	D DEPTH (MM) CENTRES	CHROME / POLISHED BRASS/SATIN BRASS	NICKEL	PEWTER	ANTIQUE BRASS/ BRONZE / GUN METAL	GOLD
						CP / BR / SB	NI	PF	AB / BZ / GM	IG
	HHCS-LONS-550-CS	CONTEMPORARY STEPPED - Single 2 leg wall mounted basin stand. Basin sold separately - suits The Water Monopoly Lonsdale 550mm basin WM-LONS-550	745	450	378	\$2,360	\$2,540	\$2,290	\$2,695	\$2,855
	HHCS-LONS-650-CS	CONTEMPORARY STEPPED - Single 2 leg wall mounted basin stand. Basin sold separately - suits The Water Monopoly Lonsdale 650mm basin WM-LONS-650	745	550	460	\$2,445	\$2,635	\$2,375	\$2,795	\$2,960
	HHCS-LONS-860-CS	CONTEMPORARY STEPPED - Single 2 leg wall mounted basin stand. Basin sold separately - suits The Water Monopoly Lonsdale 860mm basin WM-LONS-860 and WM-LONS-860R	745	750	530	\$2,545	\$2,755	\$2,480	\$2,925	\$3,100
	HHCS-PAD-920-CS	CONTEMPORARY STEPPED - Single 2 leg wall mounted basin. Basin sold separately - suits Paddington 920mm basin PADDINGTON-920	745	810	440	\$4,130	\$4,685	\$4,235	\$5,060	\$5,390

Note: Basins, benchtops, tapware and bottletraps excluded from list price and sold separately.

This document supersedes all previous pricelists and is subject to change without notice. All pricing is in NZD New Zealand Dollars. RRP Pricing incl. GST. This pricelist is published & distributed by In Residence, New Zealand. E+OE. Prices issued on 13 May 2026. V038INTD-HH



CONTEMPORARY BASIN STANDS WITH STEPPED FEET





STYLE	CODE	DESCRIPTION	DIMENSIONS			PRICING IN EACH FINISH (INCL. GST)				
			H HEIGHT (MM) OVERALL	W WIDTH (MM) CENTRES	D DEPTH (MM) CENTRES	CHROME / POLISHED BRASS/SATIN BRASS	NICKEL	PEWTER	ANTIQUE BRASS/ BRONZE / GUN METAL	GOLD
						CP / BR / SB	NI	PF	AB / BZ / GM	IG
	HHCS-LONS-550SF- CS	CONTEMPORARY STEPPED - Single 2 leg wall mounted basin stand with shelf. Basin sold separately - suits The Water Monopoly Lonsdale 550mm basin WM-LONS-550	745	450	378	\$4,265	\$4,840	\$4,380	\$5,235	\$5,575
	HHCS-LONS-650SF- CS	CONTEMPORARY STEPPED - Single 2 leg wall mounted basin stand with shelf. Basin sold separately - suits The Water Monopoly Lonsdale 650mm basin WM-LONS-650	745	550	460	\$4,440	\$5,035	\$4,560	\$5,455	\$5,810
	HHCS-LONS-860SF- CS	CONTEMPORARY STEPPED - Single 2 leg wall mounted basin stand with shelf. Basin sold separately - suits The Water Monopoly Lonsdale 860mm basin WM-LONS-860 and WM-LONS-860R	745	750	530	\$2,545	\$2,755	\$2,480	\$2,925	\$3,100
	HHCS-PAD-920SF- CS	CONTEMPORARY STEPPED - Single 2 leg wall mounted basin stand with shelf. Basin sold separately - suits Paddington 920mm basin PADDINGTON-920	745	810	440	\$4,515	\$5,130	\$4,640	\$5,550	\$5,915

Note: Basins, benchtops, tapware and bottletraps excluded from list price and sold separately.

This document supersedes all previous pricelists and is subject to change without notice. All pricing is in AUD Australian Dollars. RRP Pricing incl. GST. This pricelist is published & distributed by The English Tapware Company, Australia. E+OE. Prices issued on 13 May 2026. V038INTD-HH



CONTEMPORARY ROBE WARMERS & TOWEL BARS



	CODE	DESCRIPTION	DIMENSIONS				PRICING IN EACH FINISH (INCL. GST)				
			H	W	D	#	CHROME / POLISHED BRASS/ SATIN BRASS	NICKEL	PEWTER	ANTIQUE BRASS/ BRONZE / GUN METAL	GOLD
			HEIGHT (MM) OVERALL	WIDTH (MM) OVERALL	DEPTH(MM) OVERALL		CP / BR / SB	NI	PF	AB / BZ / GM	IG
	HHCW-525-60-1-E	CONTEMPORARY - Wall mounted electric towel bar 525mm wide x 60mm high x 136mm deep, 240V	60	525	136	1	\$1,945	\$2,115	\$1,915	\$2,275	\$2,425
	HHCW-675-60-1-E	CONTEMPORARY - Wall mounted electric towel bar 675mm wide x 60mm high x 136mm deep, 240V	60	675	136	1	\$1,965	\$2,140	\$1,935	\$2,305	\$2,455
	HHCW-825-60-1-E	CONTEMPORARY - Wall mounted electric towel bar 825mm wide x 60mm high x 136mm deep, 240V	60	825	136	1	\$2,010	\$2,185	\$1,975	\$2,345	\$2,495
	HHCW-975-60-1-E	CONTEMPORARY - Wall mounted electric towel bar 975mm wide x 60mm high x 136mm deep, 240V	60	975	136	1	\$2,080	\$2,265	\$2,055	\$2,445	\$2,605
	HHCW-ROBE-1100	CONTEMPORARY - Vertical wall mounted electric robe warmer with two hooks	1100	60	115 / 149	1	\$2,670	\$2,890	\$2,615	\$3,105	\$3,305

Note: Basins, benchtops, tapware and bottletraps excluded from list price and sold separately.

This document supersedes all previous pricelists and is subject to change without notice. All pricing is in NZD New Zealand Dollars. RRP Pricing incl. GST. This pricelist is published & distributed by In Residence, New Zealand. E+OE. Prices issued on 13 May 2026. V038INTD-HH



CONTEMPORARY TOWEL WARMERS



CODE	DESCRIPTION	DIMENSIONS				PRICING IN EACH FINISH (INCL. GST)				
		H HEIGHT (MM) OVERALL	W WIDTH (MM) OVERALL	D DEPTH (MM) OVERALL	# OF RAILS (including top and bottom)	CHROME / POLISHED BRASS/ SATIN BRASS	NICKEL	PEWTER	ANTIQUE BRASS/ BRONZE / GUN METAL	GOLD
						CP / BR / SB	NI	PF	AB / BZ / GM	IG
	HHCW-525-675-3-E CONTEMPORARY - Wall mounted electric towel bar 525mm wide x 675mm high x 136mm deep, 240V	675	525	130	3	\$4,455	\$4,750	\$4,255	\$4,885	\$5,135
	HHCW-675-675-3-E CONTEMPORARY - Wall mounted electric towel bar 675mm wide x 675mm high x 136mm deep, 240V	675	675	130	3	\$4,630	\$4,935	\$4,425	\$5,090	\$5,355
	HHCW-825-675-3-E CONTEMPORARY - Wall mounted electric towel bar 825mm wide x 675mm high x 136mm deep, 240V	675	825	136	3	\$4,860	\$5,185	\$4,650	\$5,370	\$5,655

Note: Basins, benchtops, tapware and bottletraps excluded from list price and sold separately.

This document supersedes all previous pricelists and is subject to change without notice. All pricing is in AUD Australian Dollars. RRP Pricing incl. GST.
This pricelist is published & distributed by The English Tapware Company, Australia. E+OE. Prices issued on 13 May 2026. V038INTD-HH



CONTEMPORARY TOWEL WARMERS







CODE	DESCRIPTION	DIMENSIONS					PRICING IN EACH FINISH (INCL. GST)				
		H	W	D	#	CHROME / POLISHED BRASS/ SATIN BRASS	NICKEL	PEWTER	ANTIQU BRASS/ BRONZE / GUN METAL	GOLD	
		HEIGHT (MM) OVERALL	WIDTH (MM) OVERALL	DEPTH(MM) OVERALL	OF RAILS (including top and bottom)	CP / BR / SB	NI	PF	AB / BZ / GM	IG	
	HHCW-525-975-5-E CONTEMPORARY - Wall mounted towel warmer 975mm high x 525mm wide x 136mm deep with 5 rails	975	525	136	5	\$5,395	\$5,775	\$5,190	\$6,020	\$6,355	
	HHCW-675-975-5-E CONTEMPORARY - Wall mounted towel warmer 975mm high x 675mm wide x 136mm deep with 5 rails	975	675	136	5	\$5,675	\$6,085	\$5,470	\$6,365	\$6,720	
	HHCW-825-975-5-E CONTEMPORARY - Wall mounted towel warmer 975mm high x 825mm wide x 136mm deep with 5 rails	975	825	136	5	\$5,955	\$6,395	\$5,750	\$6,705	\$7,090	

Note: Basins, benchtops, tapware and bottletraps excluded from list price and sold separately.

This document supersedes all previous pricelists and is subject to change without notice. All pricing is in NZD New Zealand Dollars. RRP Pricing incl. GST. This pricelist is published & distributed by In Residence, New Zealand. E+OE. Prices issued on 13 May 2026. V038INTD-HH



CONTEMPORARY GRAB RAILS







STYLE	CODE	DESCRIPTION	DIMENSIONS			PRICING IN EACH FINISH (INCL. GST)				
			H HEIGHT (MM) OVERALL	W WIDTH (MM) OVERALL	D DEPTH(MM) OVERALL	CHROME / POLISHED BRASS/ SATIN BRASS	NICKEL	PEWTER	ANTIQU BRASS/ BRONZE / GUN METAL	GOLD
						CP / BR / SB	NI	PF	AB / BZ / GM	IG
	HHCS-GRAB300	CONTEMPORARY - Straight grab rail with ball joints and mounts at 300mm centres.	60	300	95	\$1,275	\$1,380	\$1,245	\$1,465	\$1,555
	HHCS-GRAB450	CONTEMPORARY - Straight grab rail with ball joints and mounts at 450mm centres.	60	450	95	\$1,300	\$1,405	\$1,265	\$1,495	\$1,585
	HHCS-GRAB600	CONTEMPORARY - Straight grab rail with ball joints and mounts at 600mm centres.	60	600	95	\$1,345	\$1,450	\$1,305	\$1,535	\$1,625
	HHCS-GRAB900	CONTEMPORARY - Straight grab rail with ball joints and mounts at 900mm centres.	60	900	95	\$1,415	\$1,530	\$1,385	\$1,635	\$1,735
	HHCL-GRAB450-450	CONTEMPORARY - L-shaped grab rail with ball joints and mounts at H450 x W450mm centres.	450	450	95	\$1,825	\$1,980	\$1,790	\$2,130	\$2,265
	HHCL-GRAB600-600	CONTEMPORARY - L-shaped grab rail with ball joints and mounts at 600V x 600mmH centres.	600	600	95	\$1,940	\$2,105	\$1,905	\$2,270	\$2,415

Note: Basins, benchtops, tapware and bottletraps excluded from list price and sold separately.

This document supersedes all previous pricelists and is subject to change without notice. All pricing is in AUD Australian Dollars. RRP Pricing incl. GST.
This pricelist is published & distributed by The English Tapware Company, Australia. E+OE. Prices issued on 13 May 2026. V038INTD-HH



CONTEMPORARY GRAB RAILS

STYLE	CODE	DESCRIPTION	DIMENSIONS			PRICING IN EACH FINISH (INCL. GST)				
			H HEIGHT (MM) OVERALL	W WIDTH (MM) OVERALL	D DEPTH(MM) OVERALL	CHROME / POLISHED BRASS/ SATIN BRASS	NICKEL	PEWTER	ANTIQU BRASS/ BRONZE / GUN METAL	GOLD
						CP / BR / SB	NI	PF	AB / BZ / GM	IG
	HHCL-GRAB450-600LH	CONTEMPORARY - L-shaped grab rail with ball joints and mounts at 450V x 600mmH centres. LH	450	600	95	\$1,880	\$2,040	\$1,845	\$2,200	\$2,340
	HHCL-GRAB450-900LH	CONTEMPORARY - L-shaped grab rail with ball joints and mounts at 450V x 900mmH centres. LH	450	900	95	\$1,995	\$2,170	\$1,960	\$2,340	\$2,490
	HHCL-GRAB600-900LH	CONTEMPORARY - L-shaped grab rail with ball joints and mounts at 600V x 900mmH centres. LH	600	900	95	\$2,055	\$2,230	\$2,020	\$2,410	\$2,565
	HHCL-GRAB450-600RH	CONTEMPORARY - L-shaped grab rail with ball joints and mounts at 450V x 600mmH centres. RH	450	600	95	\$1,880	\$2,040	\$1,845	\$2,200	\$2,340
	HHCL-GRAB450-900RH	CONTEMPORARY - L-shaped grab rail with ball joints and mounts at 450V x 900mmH centres. RH	450	900	95	\$1,995	\$2,170	\$1,960	\$2,340	\$2,490
	HHCL-GRAB600-900RH	CONTEMPORARY - L-shaped grab rail with ball joints and mounts at 600V x 900mmH centres. RH	600	900	95	\$2,055	\$2,230	\$2,020	\$2,410	\$2,565

Note: Basins, benchtops, tapware and bottletraps excluded from list price and sold separately.



This document supersedes all previous pricelists and is subject to change without notice. All pricing is in NZD New Zealand Dollars. RRP Pricing incl. GST. This pricelist is published & distributed by In Residence, New Zealand. E+OE. Prices issued on 13 May 2026. V038INTD-HH



TRADITIONAL
COLLECTION



TRADITIONAL BASIN STANDS WITH BALL FEET

STYLE	CODE	DESCRIPTION	DIMENSIONS			PRICING IN EACH FINISH (INCL. GST)				
			H HEIGHT (MM) OVERALL	W WIDTH (MM) CENTRES	D DEPTH(MM) CENTRES	CHROME / POLISHED BRASS/ SATIN BRASS	NICKEL	PEWTER	ANTIQU BRASS/ BRONZE / GUN METAL	GOLD
						CP / BR / SB	NI	PF	AB / BZ / GM	IG
	HHTF-750-TB	TRADITIONAL BALL - Single 4 leg freestanding basin stand.	880	750	480	\$4,290	\$4,670	\$4,225	\$5,045	\$5,370
	HHTD-1500-TB	TRADITIONAL BALL - Double 3 leg wall mounted basin stand.	880	1500	540	\$3,800	\$4,115	\$3,715	\$4,405	\$4,680
	HHTDF-1500-TB	TRADITIONAL BALL - Double 6 leg freestanding basin stand	880	1500	480	\$8,225	\$8,980	\$8,140	\$9,785	\$10,445

Note: Basins, benchtops, tapware and bottletraps excluded from list price and sold separately.

This document supersedes all previous pricelists and is subject to change without notice. All pricing is in NZD New Zealand Dollars. RRP Pricing incl. GST. This pricelist is published & distributed by In Residence, New Zealand. E+OE. Prices issued on 13 May 2026. V038INTD-HH



TRADITIONAL BASIN STANDS WITH BALL FEET





STYLE	CODE	DESCRIPTION	DIMENSIONS			PRICING IN EACH FINISH (INCL. GST)				
			H HEIGHT (MM) OVERALL	W WIDTH (MM) CENTRES	D DEPTH (MM) CENTRES	CHROME / POLISHED BRASS/ SATIN BRASS	NICKEL	PEWTER	ANTIQUE BRASS/ BRONZE / GUN METAL	GOLD
						CP / BR / SB	NI	PF	AB / BZ / GM	IG
	HHTF-750SF-TB	TRADITIONAL BALL - Single 4 leg freestanding basin stand with shelf	880	750	480	\$7,695	\$8,785	\$7,965	\$9,600	\$10,255
	HHTD-1500SF-TB	TRADITIONAL BALL - Double 3 leg wall mounted basin stand with shelf.	880	1500	540	\$7,345	\$8,405	\$7,615	\$9,150	\$9,765
	HHTDF-1500SF-TB	TRADITIONAL BALL - Double 6 leg freestanding basin stand with shelf	880	1500	480	\$13,880	\$15,825	\$14,365	\$17,365	\$18,565
	HH-ANGLE-520	HAWTHORN HILL - Basin stand top support angle. 520mm x 32mm x 32mm. 3mm thick.	32	520	32	\$280	\$310	\$280	\$340	\$365
	HH-ANGLE-1040	HAWTHORN HILL - Basin stand top support angle. 1040mm x 32mm x 32mm. 3mm thick.	32	1040	32	\$580	\$640	\$580	\$705	\$755
	HHT-PAPERHOLDER	HAWTHORN HILL - Toilet paper holder attachment for basin stand (install at time of basin stand installation) Suits Traditional & Ornate tube size	114	183	32	\$505	\$550	\$505	\$615	\$660

Note: Basins, benchtops, tapware and bottletraps excluded from list price and sold separately.

This document supersedes all previous pricelists and is subject to change without notice. All pricing is in AUD Australian Dollars. RRP Pricing incl. GST. This pricelist is published & distributed by The English Tapware Company, Australia. E+OE. Prices issued on 13 May 2026. V038INTD-HH



TRADITIONAL BASIN STANDS WITH BALL FEET





STYLE	CODE	DESCRIPTION	DIMENSIONS			PRICING IN EACH FINISH (INCL. GST)				
			H HEIGHT (MM) OVERALL	W WIDTH (MM) CENTRES	D DEPTH(MM) CENTRES	CHROME / POLISHED BRASS/ SATIN BRASS	NICKEL	PEWTER	ANTIQUE BRASS/ BRONZE / GUN METAL	GOLD
						CP / BR / SB	NI	PF	AB / BZ / GM	IG
	HHTS-RW-480-TB	TRADITIONAL BALL - Single 2 leg wall mounted basin stand. Basin sold separately - suits The Water Monopoly Rockwell Cloakroom basin WM-RW-CLOAK	745	380	250	\$2,370	\$2,555	\$2,300	\$2,705	\$2,865
	HHTS-RW-610-TB	TRADITIONAL BALL - Single 2 leg wall mounted basin stand. Basin sold separately - suits The Water Monopoly Rockwell 610mm basin WM-RW-BASIN-610	745	455	400	\$2,455	\$2,645	\$2,385	\$2,805	\$2,975
	HHTS-RW-680-TB	TRADITIONAL BALL - Single 2 leg wall mounted basin stand. Basin sold separately - suits The Water Monopoly Rockwell 610mm basin WM-RW-BASIN-610	745	500	410	\$2,480	\$2,670	\$2,405	\$2,825	\$2,995
	HHTS-RW-750-TB	TRADITIONAL BALL - Single 2 leg wall mounted basin stand. Basin sold separately - suits The Water Monopoly Rockwell 750mm basin WM-RW-BASIN-750	745	600	455	\$2,495	\$2,690	\$2,430	\$2,860	\$3,030

Note: Basins, benchtops, tapware and bottletraps excluded from list price and sold separately.

This document supersedes all previous pricelists and is subject to change without notice. All pricing is in NZD New Zealand Dollars. RRP Pricing incl. GST. This pricelist is published & distributed by In Residence, New Zealand. E+OE. Prices issued on 13 May 2026. V038INTD-HH



TRADITIONAL BASIN STANDS WITH BALL FEET



STYLE	CODE	DESCRIPTION	DIMENSIONS			PRICING IN EACH FINISH (INCL. GST)				
			H HEIGHT (MM) OVERALL	W WIDTH (MM) CENTRES	D DEPTH (MM) CENTRES	CHROME / POLISHED BRASS/ SATIN BRASS	NICKEL	PEWTER	ANTIQUE BRASS/ BRONZE / GUN METAL	GOLD
						CP / BR / SB	NI	PF	AB / BZ / GM	IG
	HHTS-RW-480SF-TB	TRADITIONAL BALL - Single 2 leg wall mounted basin stand with shelf. Basin sold separately - suits The Water Monopoly Rockwell Cloakroom basin WM-RW-CLOAK	745	380	250	\$3,800	\$4,285	\$3,875	\$4,620	\$4,915
	HHTS-RW-610SF-TB	TRADITIONAL BALL - Single 2 leg wall mounted basin stand with shelf. Basin sold separately - suits The Water Monopoly Rockwell 610mm basin WM-RW-BASIN-610	745	455	400	\$4,190	\$4,750	\$4,300	\$5,135	\$5,470
	HHTS-RW-680SF-TB	TRADITIONAL BALL - Single 2 leg wall mounted basin stand with shelf. Basin sold separately - suits The Water Monopoly Rockwell 610mm basin WM-RW-BASIN-610	745	500	410	\$4,270	\$4,845	\$4,385	\$5,240	\$5,580
	HHTS-RW-750SF-TB	TRADITIONAL BALL - Single 2 leg wall mounted basin stand with shelf. Basin sold separately - suits The Water Monopoly Rockwell 750mm basin WM-RW-BASIN-750	745	600	455	\$4,305	\$4,880	\$4,420	\$5,280	\$5,625

Note: Basins, benchtops, tapware and bottletraps excluded from list price and sold separately.

This document supersedes all previous pricelists and is subject to change without notice. All pricing is in AUD Australian Dollars. RRP Pricing incl. GST. This pricelist is published & distributed by The English Tapware Company, Australia. E+OE. Prices issued on 13 May 2026. V038INTD-HH



TRADITIONAL SINGLE BASIN STANDS WITH POINTED FEET





STYLE	CODE	DESCRIPTION	DIMENSIONS			PRICING IN EACH FINISH (INCL. GST)				
			H HEIGHT (MM) OVERALL	W WIDTH (MM) CENTRES	D DEPTH (MM) CENTRES	CHROME / POLISHED BRASS/ SATIN BRASS	NICKEL	PEWTER	ANTIQUE BRASS/ BRONZE / GUN METAL	GOLD
						CP / BR / SB	NI	PF	AB / BZ / GM	IG
	HHTF-750-RP	TRADITIONAL POINTED - Single 4 leg freestanding basin stand.	880	750	480	\$4,290	\$4,670	\$4,225	\$5,045	\$5,370
	HHTD-1500-RP	TRADITIONAL POINTED - Double 3 leg wall mounted basin stand.	880	1500	540	\$3,800	\$4,115	\$3,715	\$4,405	\$4,680
	HHTDF-1500-RP	TRADITIONAL POINTED - Double 6 leg freestanding basin stand.	880	1500	480	\$8,225	\$8,980	\$8,140	\$9,785	\$10,445

Note: Basins, benchtops, tapware and bottletraps excluded from list price and sold separately.

This document supersedes all previous pricelists and is subject to change without notice. All pricing is in NZD New Zealand Dollars. RRP Pricing incl. GST. This pricelist is published & distributed by In Residence, New Zealand. E+OE. Prices issued on 13 May 2026. V038INTD-HH



TRADITIONAL DOUBLE BASIN STANDS WITH POINTED FEET

STYLE	CODE	DESCRIPTION	DIMENSIONS			PRICING IN EACH FINISH (INCL. GST)				
			H HEIGHT (MM) OVERALL	W WIDTH (MM) CENTRES	D DEPTH(MM) CENTRES	CHROME / POLISHED BRASS/ SATIN BRASS	NICKEL	PEWTER	ANTIQUE BRASS/ BRONZE / GUN METAL	GOLD
						CP / BR / SB	NI	PF	AB / BZ / GM	IG
	HHTF-750SF-RP	TRADITIONAL POINTED - Single 4 leg freestanding basin stand with shelf	880	750	480	\$7,695	\$8,785	\$7,965	\$9,600	\$10,255
	HHTD-1500SF-RP	TRADITIONAL POINTED - Double 3 leg wall mounted basin stand with shelf.	880	1500	540	\$7,345	\$8,405	\$7,615	\$9,150	\$9,765
	HHTDF-1500SF-RP	TRADITIONAL POINTED - Double 6 leg freestanding basin stand with shelf	880	1500	480	\$13,880	\$15,825	\$14,365	\$17,365	\$18,565
	HH-ANGLE-520	HAWTHORN HILL - Basin stand top support angle. 520mm x 32mm x 32mm. 3mm thick.	32	520	32	\$280	\$310	\$280	\$340	\$365
	HH-ANGLE-1040	HAWTHORN HILL - Basin stand top support angle. 1040mm x 32mm x 32mm. 3mm thick.	32	1040	32	\$580	\$640	\$580	\$705	\$755
	HHT-PAPERHOLDER	HAWTHORN HILL - Toilet paper holder attachment for basin stand (install at time of basin stand installation) Suits Traditional & Ornate tube size	114	183	32	\$505	\$550	\$505	\$615	\$660

Note: Basins, benchtops, tapware and bottletraps excluded from list price and sold separately.

This document supersedes all previous pricelists and is subject to change without notice. All pricing is in AUD Australian Dollars. RRP Pricing incl. GST. This pricelist is published & distributed by The English Tapware Company, Australia. E+OE. Prices issued on 13 May 2026. V038INTD-HH



TRADITIONAL TOWEL WARMERS

CODE	DESCRIPTION	DIMENSIONS				PRICING IN EACH FINISH (INCL. GST)				
		H	W	D	#	CHROME / POLISHED BRASS/ SATIN BRASS	NICKEL	PEWTER	ANTIQUE BRASS/ BRONZE / GUN METAL	GOLD
		HEIGHT (MM) OVERALL	WIDTH (MM) OVERALL	DEPTH(MM) OVERALL	OF RAILS (including top and bottom)	CP / BR / SB	NI	PF	AB / BZ / GM	IG
 HHTW-525-675-3-E	TRADITIONAL - Wall mounted electric towel warmer 525mm wide x 675mm high x 138mm deep, 240V	675	525	138	3	\$4,605	\$4,910	\$4,400	\$5,065	\$5,325
 HHTW-675-675-3-E	TRADITIONAL - Wall mounted electric towel warmer 675mm wide x 675mm high x 138mm deep, 240V	675	675	138	3	\$4,780	\$5,100	\$4,575	\$5,275	\$5,555
 HHTW-825-675-3-E	TRADITIONAL - Wall mounted electric towel warmer 825mm wide x 675mm high x 138mm deep, 240V	675	825	138	3	\$5,010	\$5,325	\$4,765	\$5,450	\$5,725

Note: Basins, benchtops, tapware and bottletraps excluded from list price and sold separately.

This document supersedes all previous pricelists and is subject to change without notice. All pricing is in NZD New Zealand Dollars. RRP Pricing incl. GST. This pricelist is published & distributed by In Residence, New Zealand. E+OE. Prices issued on 13 May 2026. V038INTD-HH



TRADITIONAL TOWEL WARMERS





CODE	DESCRIPTION	DIMENSIONS					PRICING IN EACH FINISH (INCL. GST)				
		H	W	D	#	CHROME / POLISHED BRASS/ SATIN BRASS	NICKEL	PEWTER	ANTIQUE BRASS/ BRONZE / GUN METAL	GOLD	
		HEIGHT (MM) OVERALL	WIDTH (MM) OVERALL	DEPTH(MM) OVERALL		CP / BR / SB	NI	PF	AB / BZ / GM	IG	
 HHTW-525-975-5-E	TRADITIONAL - Wall mounted towel warmer 975mm high x 525mm wide x 138mm deep with 5 rails	975	525	138	5	\$5,290	\$5,665	\$5,085	\$5,895	\$6,220	
 HHTW-675-975-5-E	TRADITIONAL - Wall mounted towel warmer 975mm high x 675mm wide x 138mm deep with 5 rails	975	675	138	5	\$5,570	\$5,975	\$5,370	\$6,240	\$6,590	
 HHTW-825-975-5-E	TRADITIONAL - Wall mounted towel warmer 975mm high x 825mm wide x 138mm deep with 5 rails	975	825	138	5	\$5,855	\$6,285	\$5,650	\$6,585	\$6,955	

Note: Basins, benchtops, tapware and bottletraps excluded from list price and sold separately.

This document supersedes all previous pricelists and is subject to change without notice. All pricing is in AUD Australian Dollars. RRP Pricing incl. GST.
This pricelist is published & distributed by The English Tapware Company, Australia. E+OE. Prices issued on 13 May 2026. V038INTD-HH



TRADITIONAL ROBE WARMERS & TOWEL BARS







STYLE	CODE	DESCRIPTION	DIMENSIONS			PRICING IN EACH FINISH (INCL. GST)				
			H HEIGHT (MM) OVERALL	W WIDTH (MM) OVERALL	D DEPTH(MM) OVERALL	CHROME / POLISHED BRASS/ SATIN BRASS	NICKEL	PEWTER	ANTIQUE BRASS/ BRONZE / GUN METAL	GOLD
						CP / BR / SB	NI	PF	AB / BZ / GM	IG
	HHTW-525-75-1-E	TRADITIONAL - Wall mounted electric towel bar 525mm wide x 75mm high x 138mm deep, 240V	75	525	138	\$1,945	\$2,115	\$1,915	\$2,275	\$2,425
	HHTW-675-75-1-E	TRADITIONAL - Wall mounted electric towel bar 675mm wide x 75mm high x 138mm deep, 240V	75	675	138	\$1,965	\$2,140	\$1,935	\$2,305	\$2,455
	HHTW-825-75-1-E	TRADITIONAL - Wall mounted electric towel bar 825mm wide x 75mm high x 138mm deep, 240V	75	825	138	\$2,010	\$2,185	\$1,975	\$2,345	\$2,495
	HHTW-975-75-1-E	TRADITIONAL - Wall mounted electric towel bar 975mm wide x 75mm high x 138mm deep, 240V	75	975	138	\$2,080	\$2,265	\$2,055	\$2,445	\$2,605
	HHTW-ROBE-1100	TRADITIONAL - Vertical wall mounted electric robe warmer with two hooks	1100	82	115 / 145	\$2,670	\$2,890	\$2,615	\$3,105	\$3,305

Note: Basins, benchtops, tapware and bottletraps excluded from list price and sold separately.

This document supersedes all previous pricelists and is subject to change without notice. All pricing is in NZD New Zealand Dollars. RRP Pricing incl. GST. This pricelist is published & distributed by In Residence, New Zealand. E+0E. Prices issued on 13 May 2026. V038INTD-HH



TRADITIONAL GRAB RAILS







STYLE	CODE	DESCRIPTION	DIMENSIONS			PRICING IN EACH FINISH (INCL. GST)				
			H HEIGHT (MM) OVERALL	W WIDTH (MM) OVERALL	D DEPTH(MM) OVERALL	CHROME / POLISHED BRASS/ SATIN BRASS	NICKEL	PEWTER	ANTIQUE BRASS/ BRONZE / GUN METAL	GOLD
						CP / BR / SB	NI	PF	AB / BZ / GM	IG
	HHTS-GRAB300	TRADITIONAL - Straight grab rail with ball joints and mounts at 300mm centres.	75	300	95	\$1,185	\$1,275	\$1,150	\$1,355	\$1,435
	HHTS-GRAB450	TRADITIONAL - Straight grab rail with ball joints and mounts at 450mm centres.	75	450	95	\$1,240	\$1,340	\$1,210	\$1,425	\$1,510
	HHTS-GRAB600	TRADITIONAL - Straight grab rail with ball joints and mounts at 600mm centres.	75	600	95	\$1,345	\$1,450	\$1,310	\$1,535	\$1,625
	HHTS-GRAB900	TRADITIONAL - Straight grab rail with ball joints and mounts at 900mm centres.	75	900	95	\$1,415	\$1,530	\$1,385	\$1,635	\$1,735
	HHTL-GRAB450-450	TRADITIONAL - L-shaped grab rail with ball joints and mounts at H450 x W450mm centres.	450	450	95	\$1,825	\$1,980	\$1,790	\$2,130	\$2,265
	HHTL-GRAB600-600	TRADITIONAL - L-shaped grab rail with ball joints and mounts at 600V x 600mmH centres.	600	600	95	\$1,940	\$2,105	\$1,905	\$2,270	\$2,415

Note: Basins, benchtops, tapware and bottletraps excluded from list price and sold separately.

This document supersedes all previous pricelists and is subject to change without notice. All pricing is in AUD Australian Dollars. RRP Pricing incl. GST. This pricelist is published & distributed by The English Tapware Company, Australia. E+OE. Prices issued on 13 May 2026. V038INTD-HH



TRADITIONAL GRAB RAILS

STYLE	CODE	DESCRIPTION	DIMENSIONS			PRICING IN EACH FINISH (INCL. GST)				
			H HEIGHT (MM) OVERALL	W WIDTH (MM) OVERALL	D DEPTH(MM) OVERALL	CHROME / POLISHED BRASS/ SATIN BRASS	NICKEL	PEWTER	ANTIQUE BRASS/ BRONZE / GUN METAL	GOLD
						CP / BR / SB	NI	PF	AB / BZ / GM	IG
	HHTL-GRAB450-600LH	TRADITIONAL - L-shaped grab rail with ball joints and mounts at 450V x 600mmH centres. LH	450	600	95	\$1,880	\$2,040	\$1,845	\$2,200	\$2,340
	HHTL-GRAB450-900LH	TRADITIONAL - L-shaped grab rail with ball joints and mounts at 450V x 900mmH centres. LH	450	900	95	\$1,995	\$2,170	\$1,960	\$2,340	\$2,490
	HHTL-GRAB600-900LH	TRADITIONAL - L-shaped grab rail with ball joints and mounts at 600V x 900mmH centres. LH	600	900	95	\$2,055	\$2,230	\$2,020	\$2,410	\$2,565
	HHTL-GRAB450-600RH	TRADITIONAL - L-shaped grab rail with ball joints and mounts at 450V x 600mmH centres. RH	450	600	95	\$1,880	\$2,040	\$1,845	\$2,200	\$2,340
	HHTL-GRAB450-900RH	TRADITIONAL - L-shaped grab rail with ball joints and mounts at 450V x 900mmH centres. RH	450	900	95	\$1,995	\$2,170	\$1,960	\$2,340	\$2,490
	HHTL-GRAB600-900RH	TRADITIONAL - L-shaped grab rail with ball joints and mounts at 600V x 900mmH centres. RH	600	900	95	\$2,055	\$2,230	\$2,020	\$2,410	\$2,565

Note: Basins, benchtops, tapware and bottletraps excluded from list price and sold separately.

This document supersedes all previous pricelists and is subject to change without notice. All pricing is in NZD New Zealand Dollars. RRP Pricing incl. GST. This pricelist is published & distributed by In Residence, New Zealand. E+OE. Prices issued on 13 May 2026. V038INTD-HH



ORNATE
COLLECTION



ORNATE BASIN STANDS WITH POINTED FEET

STYLE	CODE	DESCRIPTION	DIMENSIONS			PRICING IN EACH FINISH (INCL. GST)				
			H HEIGHT (MM) CENTRES	W WIDTH (MM) CENTRES	D DEPTH (MM) CENTRES	CHROME / POLISHED BRASS/ SATIN BRASS	NICKEL	PEWTER	ANTIQUE BRASS/ BRONZE / GUN METAL	GOLD
						CP / BR / SB	NI	PF	AB / BZ / GM	IG
	HHRC-PARIS-650-RP	ORNATE POINTED - Single 2 leg wall mounted basin stand. Basin sold separately - suits The Water Monopoly Paris basin 650mm wide.	745	480	375	\$3,350	\$3,635	\$3,285	\$3,900	\$4,145
	HHRC-PARIS-760-RP	ORNATE POINTED - Single 2 leg wall mounted basin stand. Basin sold separately - suits The Water Monopoly Paris basin 760mm wide.	745	600	375	\$3,390	\$3,680	\$3,325	\$3,950	\$4,200
	HHRC-PARIS-1020-RP	ORNATE POINTED - Single 2 leg wall mounted basin stand. Basin sold separately - suits The Water Monopoly Paris basin 1020mm wide.	745	820	360	\$3,725	\$4,035	\$3,645	\$4,315	\$4,580
	HHRC-PARIS-1410-RP	ORNATE POINTED - Single 2 leg wall mounted basin stand. Basin sold separately - suits The Water Monopoly Paris basin 1410mm wide.	745	1270	400	\$4,240	\$4,600	\$4,155	\$4,935	\$5,250

Note: Basins, benchtops, tapware and bottletraps excluded from list price and sold separately.

This document supersedes all previous pricelists and is subject to change without notice. All pricing is in NZD New Zealand Dollars. RRP Pricing incl. GST. This pricelist is published & distributed by In Residence, New Zealand. E+0E. Prices issued on 13 May 2026. V038INTD-HH



ORNATE BASIN STANDS WITH POINTED FEET



STYLE	CODE	DESCRIPTION	DIMENSIONS			PRICING IN EACH FINISH (INCL. GST)				
			H HEIGHT (MM) CENTRES	W WIDTH (MM) CENTRES	D DEPTH (MM) CENTRES	CHROME / POLISHED BRASS/ SATIN BRASS	NICKEL	PEWTER	ANTIQUE BRASS/ BRONZE / GUN METAL	GOLD
						CP / BR / SB	NI	PF	AB / BZ / GM	IG
	HHRC-PARIS-650SF-RP	ORNATE POINTED - Single 2 leg wall mounted basin stand with shelf. Basin sold separately - suits The Water Monopoly Paris basin 650mm wide.	745	480	375	\$5,125	\$5,780	\$5,230	\$6,270	\$6,685
	HHRC-PARIS-760SF-RP	ORNATE POINTED - Single 2 leg wall mounted basin stand with shelf. Basin sold separately - suits The Water Monopoly Paris basin 760mm wide.	745	600	375	\$5,165	\$5,825	\$5,275	\$6,320	\$6,740
	HHRC-PARIS-1020SF-RP	ORNATE POINTED - Single 2 leg wall mounted basin stand with shelf. Basin sold separately - suits The Water Monopoly Paris basin 1020mm wide.	745	820	360	\$5,495	\$6,430	\$6,685	\$6,685	\$7,120
	HHRC-PARIS-1410SF-RP	ORNATE POINTED - Single 2 leg wall mounted basin stand with shelf. Basin sold separately - suits The Water Monopoly Paris basin 1410mm wide.	745	1270	400	\$6,010	\$6,745	\$6,105	\$7,310	\$7,790

Note: Basins, benchtops, tapware and bottletraps excluded from list price and sold separately.

This document supersedes all previous pricelists and is subject to change without notice. All pricing is in AUD Australian Dollars. RRP Pricing incl. GST. This pricelist is published & distributed by The English Tapware Company, Australia. E+OE. Prices issued on 13 May 2026. V038INTD-HH



ORNATE BASIN STANDS WITH POINTED FEET





STYLE	CODE	DESCRIPTION	DIMENSIONS			PRICING IN EACH FINISH (INCL. GST)				
			H HEIGHT (MM) CENTRES	W WIDTH (MM) CENTRES	D DEPTH (MM) CENTRES	CHROME / POLISHED BRASS/ SATIN BRASS	NICKEL	PEWTER	ANTIQUE BRASS/ BRONZE / GUN METAL	GOLD
						CP / BR / SB	NI	PF	AB / BZ / GM	IG
	HHRF-750-RP	ORNATE POINTED - Single 4 leg freestanding basin stand.	880	750	480	\$4,290	\$4,670	\$4,225	\$5,045	\$5,370
	HHRD-1500-RP	ORNATE POINTED - Double 3 leg wall mounted basin stand.	880	1500	540	\$3,800	\$4,115	\$3,715	\$4,405	\$4,680
	HHRDF-1500-RP	ORNATE POINTED - Double 6 leg freestanding basin stand.	880	1500	480	\$8,225	\$8,980	\$8,140	\$9,785	\$10,445

Note: Basins, benchtops, tapware and bottletraps excluded from list price and sold separately.

This document supersedes all previous pricelists and is subject to change without notice. All pricing is in NZD New Zealand Dollars. RRP Pricing incl. GST. This pricelist is published & distributed by In Residence, New Zealand. E+OE. Prices issued on 13 May 2026. V038INTD-HH



ORNATE BASIN STANDS WITH POINTED FEET

STYLE	CODE	DESCRIPTION	DIMENSIONS			PRICING IN EACH FINISH (INCL. GST)				
			H HEIGHT (MM) CENTRES	W WIDTH (MM) CENTRES	D DEPTH (MM) CENTRES	CHROME / POLISHED BRASS/ SATIN BRASS	NICKEL	PEWTER	ANTIQUE BRASS/ BRONZE / GUN METAL	GOLD
						CP / BR / SB	NI	PF	AB / BZ / GM	IG
	HHRF-750SF- RP	ORNATE POINTED - Single 4 leg freestanding basin stand with shelf	880	750	480	\$7,695	\$8,785	\$7,965	\$9,600	\$10,255
	HHRD-1500SF- RP	ORNATE POINTED - Double 3 leg wall mounted basin stand with shelf.	880	1500	540	\$7,345	\$8,405	\$7,615	\$9,150	\$9,765
	HHRDF- 1500SF-RP	ORNATE POINTED - Double 6 leg freestanding basin stand with shelf	880	1500	480	\$13,880	\$15,825	\$14,365	\$17,365	\$18,565
	HH-ANGLE-520	HAWTHORN HILL - Basin stand top support angle. 520mm x 32mm x 32mm. 3mm thick.	32	520	32	\$280	\$310	\$280	\$340	\$365
	HH- ANGLE-1040	HAWTHORN HILL - Basin stand top support angle. 1040mm x 32mm x 32mm. 3mm thick.	32	1040	32	\$580	\$640	\$580	\$705	\$755
	HHT- PAPERHOLDER	HAWTHORN HILL - Toilet paper holder attachment for basin stand (install at time of basin stand installation) Suits Traditional & Ornate tube size	114	183	32	\$505	\$550	\$505	\$615	\$660

Note: Basins, benchtops, tapware and bottletraps excluded from list price and sold separately.

This document supersedes all previous pricelists and is subject to change without notice. All pricing is in AUD Australian Dollars. RRP Pricing incl. GST.
This pricelist is published & distributed by The English Tapware Company, Australia. E+OE. Prices issued on 13 May 2026. V038INTD-HH



ORNATE TOWEL WARMERS

CODE	DESCRIPTION	DIMENSIONS				PRICING IN EACH FINISH (INCL. GST)				
		H HEIGHT (MM) OVERALL	W WIDTH (MM) OVERALL	D DEPTH(MM) OVERALL	# OF RAILS (including top and bottom)	CHROME / POLISHED BRASS/ SATIN BRASS	NICKEL	PEWTER	ANTIQUE BRASS/ BRONZE / GUN METAL	GOLD
						CP / BR / SB	NI	PF	AB / BZ / GM	IG
 HHRW-525-675-3-E	ORNATE - Wall mounted electric towel warmer 525mm wide x 675mm high x 138mm deep, 240V	675	525	138	3	\$4,875	\$5,210	\$4,675	\$5,395	\$5,680
 HHRW-675-675-3-E	ORNATE - Wall mounted electric towel warmer 675mm wide x 675mm high x 138mm deep, 240V	675	675	138	3	\$5,050	\$5,395	\$4,845	\$5,600	\$5,905
 HHRW-825-675-3-E	ORNATE - Wall mounted electric towel warmer 825mm wide x 675mm high x 138mm deep, 240V	675	825	138	3	\$5,280	\$5,610	\$5,025	\$5,750	\$6,040

Note: Basins, benchtops, tapware and bottletraps excluded from list price and sold separately.

This document supersedes all previous pricelists and is subject to change without notice. All pricing is in NZD New Zealand Dollars. RRP Pricing incl. GST. This pricelist is published & distributed by In Residence, New Zealand. E+OE. Prices issued on 13 May 2026. V038INTD-HH



ORNATE TOWEL WARMERS



CODE	DESCRIPTION	DIMENSIONS					PRICING IN EACH FINISH (INCL. GST)				
		H	W	D	#	CHROME / POLISHED BRASS/ SATIN BRASS	NICKEL	PEWTER	ANTIQUE BRASS/ BRONZE / GUN METAL	GOLD	
		HEIGHT (MM) OVERALL	WIDTH (MM) OVERALL	DEPTH(MM) OVERALL		CP / BR / SB	NI	PF	AB / BZ / GM	IG	
	HHRW-525-975-5-E ORNATE - Wall mounted towel warmer 975mm high x 525mm wide x 138mm deep with 5 rails	975	525	138	5	\$5,625	\$6,025	\$5,420	\$6,300	\$6,655	
	HHRW-675-975-5-E ORNATE - Wall mounted towel warmer 975mm high x 675mm wide x 138mm deep with 5 rails	975	675	138	5	\$5,905	\$6,335	\$5,700	\$6,645	\$7,020	
	HHRW-825-975-5-E ORNATE - Wall mounted towel warmer 975mm high x 825mm wide x 138mm deep with 5 rails	975	825	138	5	\$6,185	\$6,645	\$5,980	\$6,985	\$7,390	

Note: Basins, benchtops, tapware and bottletraps excluded from list price and sold separately.

This document supersedes all previous pricelists and is subject to change without notice. All pricing is in AUD Australian Dollars. RRP Pricing incl. GST. This pricelist is published & distributed by The English Tapware Company, Australia. E+OE. Prices issued on 13 May 2026. V038INTD-HH



ORNATE VERTICAL ROBE WARMERS







STYLE	CODE	DESCRIPTION	DIMENSIONS			PRICING IN EACH FINISH (INCL. GST)				
			H HEIGHT (MM) OVERALL	W WIDTH (MM) OVERALL	D DEPTH(MM) OVERALL	CHROME / POLISHED BRASS/ SATIN BRASS	NICKEL	PEWTER	ANTIQUE BRASS/ BRONZE / GUN METAL	GOLD
						CP / BR / SB	NI	PF	AB / BZ / GM	IG
	HHRW-525-75-1-E	ORNATE - Wall mounted electric towel bar 525mm wide x 75mm high x 138mm deep, 240V	75	525	138	\$1,945	\$2,115	\$1,915	\$2,275	\$2,425
	HHRW-675-75-1-E	ORNATE - Wall mounted electric towel bar 675mm wide x 75mm high x 138mm deep, 240V	75	675	138	\$1,965	\$2,140	\$1,935	\$2,305	\$2,455
	HHRW-825-75-1-E	ORNATE - Wall mounted electric towel bar 825mm wide x 75mm high x 138mm deep, 240V	75	825	138	\$2,010	\$2,185	\$1,975	\$2,345	\$2,495
	HHRW-975-75-1-E	ORNATE - Wall mounted electric towel bar 975mm wide x 75mm high x 138mm deep, 240V	75	975	138	\$2,080	\$2,265	\$2,055	\$2,445	\$2,605
	HHRW-ROBE-1100	ORNATE - Vertical robe warmer with two hooks	1100	82	115 / 145	\$2,670	\$2,890	\$2,615	\$3,105	\$3,305

Note: Basins, benchtops, tapware and bottletraps excluded from list price and sold separately.

This document supersedes all previous pricelists and is subject to change without notice. All pricing is in NZD New Zealand Dollars. RRP Pricing incl. GST. This pricelist is published & distributed by In Residence, New Zealand. E+OE. Prices issued on 13 May 2026. V038INTD-HH



ORNATE GRAB RAILS







STYLE	CODE	DESCRIPTION	DIMENSIONS			PRICING IN EACH FINISH (INCL. GST)				
			H	W	D	CHROME / POLISHED BRASS/ SATIN BRASS	NICKEL	PEWTER	ANTIQUE BRASS/ BRONZE / GUN METAL	GOLD
			HEIGHT (MM) OVERALL	WIDTH (MM) OVERALL	DEPTH(MM) OVERALL	CP / BR / SB	NI	PF	AB / BZ / GM	IG
	HHRS-GRAB300	ORNATE - Straight grab rail with ball joints and mounts at 300mm centres.	75	300	95	\$1,185	\$1,275	\$1,150	\$1,355	\$1,435
	HHRS-GRAB450	ORNATE - Straight grab rail with ball joints and mounts at 450mm centres.	75	450	95	\$1,240	\$1,340	\$1,210	\$1,425	\$1,510
	HHRS-GRAB600	ORNATE - Straight grab rail with ball joints and mounts at 600mm centres.	75	600	95	\$1,345	\$1,450	\$1,305	\$1,535	\$1,625
	HHRS-GRAB900	ORNATE - Straight grab rail with ball joints and mounts at 900mm centres.	75	900	95	\$1,415	\$1,530	\$1,385	\$1,635	\$1,735
	HHRL-GRAB450-450	ORNATE - L-shaped grab rail with ball joints and mounts at H450 x W450mm centres.	450	450	95	\$1,825	\$1,980	\$1,790	\$2,130	\$2,265
	HHRL-GRAB600-600	ORNATE - L-shaped grab rail with ball joints and mounts at 600V x 600mmH centres.	600	600	95	\$1,940	\$2,105	\$1,905	\$2,270	\$2,415

Note: Basins, benchtops, tapware and bottletraps excluded from list price and sold separately.

This document supersedes all previous pricelists and is subject to change without notice. All pricing is in AUD Australian Dollars. RRP Pricing incl. GST. This pricelist is published & distributed by The English Tapware Company, Australia. E+OE. Prices issued on 13 May 2026. V038INTD-HH



ORNATE GRAB RAILS

STYLE	CODE	DESCRIPTION	DIMENSIONS			PRICING IN EACH FINISH (INCL. GST)				
			H HEIGHT (MM) OVERALL	W WIDTH (MM) OVERALL	D DEPTH(MM) OVERALL	CHROME / POLISHED BRASS/ SATIN BRASS	NICKEL	PEWTER	ANTIQUE BRASS/ BRONZE / GUN METAL	GOLD
						CP / BR / SB	NI	PF	AB / BZ / GM	IG
	HHRL-GRAB450-600LH	ORNATE - L-shaped grab rail with ball joints and mounts at 450V x 600mmH centres. LH	450	600	95	\$1,880	\$2,040	\$1,845	\$2,200	\$2,340
	HHRL-GRAB450-900LH	ORNATE - L-shaped grab rail with ball joints and mounts at 450V x 900mmH centres. LH	450	900	95	\$1,995	\$2,170	\$1,960	\$2,340	\$2,490
	HHRL-GRAB600-900LH	ORNATE - L-shaped grab rail with ball joints and mounts at 600V x 900mmH centres. LH	600	900	95	\$2,055	\$2,230	\$2,020	\$2,410	\$2,565
	HHRL-GRAB450-600RH	ORNATE - L-shaped grab rail with ball joints and mounts at 450V x 600mmH centres. RH	450	600	95	\$1,880	\$2,040	\$1,845	\$2,200	\$2,340
	HHRL-GRAB450-900RH	ORNATE - L-shaped grab rail with ball joints and mounts at 450V x 900mmH centres. RH	450	900	95	\$1,995	\$2,170	\$1,960	\$2,340	\$2,490
	HHRL-GRAB600-900RH	ORNATE - L-shaped grab rail with ball joints and mounts at 600V x 900mmH centres. RH	600	900	95	\$2,055	\$2,230	\$2,020	\$2,410	\$2,565

Note: Basins, benchtops, tapware and bottletraps excluded from list price and sold separately.





This document supersedes all previous pricelists and is subject to change without notice. All pricing is in NZD New Zealand Dollars. RRP Pricing incl. GST. This pricelist is published & distributed by In Residence, New Zealand. E+OE. Prices issued on 13 May 2026. V038INTD-HH



MIRRORS
& ACCESSORIES



FIXED & SHAVING CABINET MIRRORS

STYLE	CODE	DESCRIPTION	PRICING IN EACH FINISH (INCL. GST)						
			H _{HEIGHT(MM)} OVERALL	W _{WIDTH(MM)} OVERALL	CHROME / POLISHED BRASS/ SATIN BRASS	NICKEL	PEWTER	ANTIQUE BRASS/ BRONZE / GUN METAL	GOLD
					CP / BR / SB	NI	PF	AB / BZ / GM	IG
	HH-MIRRORFIXED-A	Small rectangular bathroom mirror with metal frame.	600	400	\$2,095	\$2,255	\$2,030	\$2,385	\$2,530
	HH-HINGED-MIRROR-A	Small rectangular bathroom mirror with metal frame and piano hinges to use in conjunction with builder to create a custom shaving cabinet.	600	400			COMING SOON		
	HH-MIRRORFIXED-B	Medium rectangular bathroom mirror with metal frame.	800	600	\$2,750	\$2,975	\$2,685	\$3,185	\$3,380
	HH-MIRRORFIXED-C	Large rectangular bathroom mirror with metal frame.	900	750	\$3,155	\$3,425	\$3,095	\$3,685	\$3,915

Note: Basins, benchtops, tapware and bottletraps excluded from list price and sold separately.

This document supersedes all previous pricelists and is subject to change without notice. All pricing is in NZD New Zealand Dollars. RRP Pricing incl. GST. This pricelist is published & distributed by In Residence, New Zealand. E+OE. Prices issued on 13 May 2026. V038INTD-HH



CLASSICAL TILTING MIRRORS





STYLE	CODE	DESCRIPTION	PRICING IN EACH FINISH (INCL. GST)				
			CHROME / POLISHED BRASS/ SATIN BRASS CP / BR / SB	NICKEL NI	PEWTER PF	ANTIQUE BRASS/ BRONZE / GUN METAL AB / BZ / GM	GOLD IG
	HH-MIRRORRADIUS	Rectangular tilting bathroom mirror with radius on corners 800h x 508w (612w incl. brackets)	\$2,785	\$3,015	\$2,725	\$3,230	\$3,430
	HH-MIRROROVAL-A	Oval tilting bathroom mirror with metal frame 760h x 620w (730w incl. brackets)	\$2,790	\$3,020	\$2,725	\$3,235	\$3,435
	HH-MIRROROVAL-B	Oval tilting bathroom mirror with metal frame 570h x 465w (570w incl. brackets)	\$2,405	\$2,600	\$2,345	\$2,770	\$2,940
	HH-MIRRORROUND	Round tilting bathroom mirror with metal frame. 533 dia. (643w incl. brackets)	\$2,385	\$2,575	\$2,325	\$2,745	\$2,910
	HH-MIRRORSQUARE	Square tilting bathroom mirror with metal frame 508h x 508w (618w incl. brackets)	\$2,385	\$2,575	\$2,325	\$2,745	\$2,910
	HH-MIRRORRECTANGL	Rectangular tilting bathroom mirror with frame 762h x 610w (720w incl brackets)	\$2,790	\$3,020	\$2,725	\$3,235	\$3,435

Note: Basins, benchtops, tapware and bottletraps excluded from list price and sold separately.

This document supersedes all previous pricelists and is subject to change without notice. All pricing is in AUD Australian Dollars. RRP Pricing incl. GST. This pricelist is published & distributed by The English Tapware Company, Australia. E+OE. Prices issued on 13 May 2026. V038INTD-HH



VANITY MIRRORS

STYLE	CODE	DESCRIPTION	PRICING IN EACH FINISH (INCL. GST)				
			CHROME / POLISHED BRASS/ SATIN BRASS	NICKEL	PEWTER	ANTIQUE BRASS/ BRONZE / GUN METAL	GOLD
			CP / BR / SB	NI	PF	AB / BZ / GM	IG
	HH-MIRRORPIVSHAVE	Pivoting style shaving mirror. Pivots out to 240mm. 180mm dia. 1x and 3x mag.	\$1,030	\$1,085	\$970	\$1,090	\$1,140
	HH-MIRROREXTSHAVE	Concertina style shaving mirror. Extends 100 to 475mm. 180mm dia. 1x and 3x mag.	\$1,550	\$1,660	\$1,495	\$1,735	\$1,830
	HH-MIRRORTABLE-S	Short freestanding table mirror. Base: 130mm Mirror:200mm dia. 1x and 3x mag.	\$975	\$1,030	\$915	\$1,025	\$1,070
	HH-MIRRORTABLE-T	Tall freestanding table mirror. Mirror:200mm dia. 1x and 3x mag.	\$1,155	\$1,225	\$1,095	\$1,245	\$1,305

Note: Basins, benchtops, tapware and bottletraps excluded from list price and sold separately.

This document supersedes all previous pricelists and is subject to change without notice. All pricing is in NZD New Zealand Dollars. RRP Pricing incl. GST. This pricelist is published & distributed by In Residence, New Zealand. E+OE. Prices issued on 13 May 2026. V038INTD-HH



BATHROOM STANDS & TOWEL RACKS





STYLE	CODE	DESCRIPTION	PRICING IN EACH FINISH (INCL. GST)				
			CHROME / POLISHED BRASS/ SATIN BRASS CP / BR / SB	NICKEL NI	PEWTER PF	ANTIQUE BRASS/ BRONZE / GUN METAL AB / BZ / GM	GOLD IG
	HH-BATHSTAND350	Bathroom stand with three glass shelves. 350W x 830H x 350D	\$3,145	\$3,460	\$3,145	\$3,830	\$4,105
	HH-BATHSTAND500	Bathroom stand with three glass shelves. 500W x 830H x 350D	\$3,375	\$3,690	\$3,345	\$4,030	\$4,305
	HHCA600-850N	CONTEMPORARY - Arched towel rack with 7 rails Note: These are no longer available heated due to installation regulations	\$7,835	\$8,465	\$7,635	\$8,995	\$9,540
	HHTA600-850N	TRADITIONAL - Arched towel rack with 7 rails Note: These are no longer available heated due to installation regulations	\$7,835	\$8,465	\$7,635	\$8,995	\$9,540
	HHRA600-850N	ORNATE - Arched towel rack with 7 rails Note: These are no longer available heated due to installation regulations	\$6,815	\$7,360	\$7,635	\$8,995	\$9,540

Note: Basins, benchtops, tapware and bottletraps excluded from list price and sold separately.

This document supersedes all previous pricelists and is subject to change without notice. All pricing is in AUD Australian Dollars. RRP Pricing incl. GST. This pricelist is published & distributed by The English Tapware Company, Australia. E+OE. Prices issued on 13 May 2026. V038INTD-HH

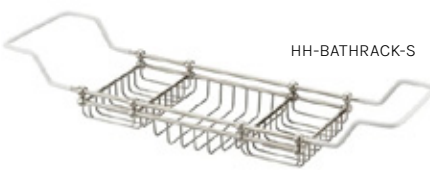

BATH RACKS





STYLE	CODE	DESCRIPTION	PRICING IN EACH FINISH (INCL. GST)				
			CHROME / POLISHED BRASS/ SATIN BRASS	NICKEL	PEWTER	ANTIQUE BRASS/ BRONZE / GUN METAL	GOLD
			CP / BR / SB	NI	PF	AB / BZ / GM	IG
	HH-BATHRACK-MF	HAWTHORN HILL - Bathrack with extending arms 725-855mm & fixed vanity mirror	\$1,635	\$1,720	\$1,535	\$1,725	\$1,800
	HH-BATHRACK-MS	HAWTHORN HILL - Bathrack with extending arms 725-855mm & swivel vanity mirror	\$1,635	\$1,720	\$1,535	\$1,725	\$1,800
	HH-BATHRACK-S	HAWTHORN HILL - Bathrack with extending arms 725-855mm	\$1,145	\$1,260	\$1,145	\$1,390	\$1,490
	HH-BATHRACK-L	HAWTHORN HILL - Oversized Large bathrack with extending arms 895-955mm	\$1,260	\$1,340	\$1,195	\$1,365	\$1,435
	HH-BOOKREST	HAWTHORN HILL - Bookrest for Hawthorn Hill bathracks	\$510	\$565	\$510	\$620	\$665

Note: Basins, benchtops, tapware and bottletraps excluded from list price and sold separately.

This document supersedes all previous pricelists and is subject to change without notice. All pricing is in NZD New Zealand Dollars. RRP Pricing incl. GST. This pricelist is published & distributed by In Residence, New Zealand. E+OE. Prices issued on 13 May 2026. V038INTD-HH



DECO MIRRORS

STYLE	CODE	DESCRIPTION	PRICING IN EACH FINISH (INCL. GST)				
			CHROME / POLISHED BRASS/ SATIN BRASS CP / BR / SB	NICKEL NI	PEWTER PF	ANTIQUE BRASS/ BRONZE / GUN METAL AB / BZ / GM	GOLD IG
	HH-MIRROR-OV-DECO	Oval tilting bathroom mirror with metal frame with Deco style pivot brackets 760h x 620w (730w incl. brackets)	\$2,835	\$3,070	\$2,770	\$3,290	\$3,495
	HH-MIRROR-RD-DECO	Round tilting bathroom mirror with metal frame with Deco style pivot brackets 533 dia. (643w incl. brackets)	\$2,420	\$2,620	\$2,365	\$2,790	\$2,960
	HH-MIRROR-SQ-DECO	Square tilting bathroom mirror with metal frame with Deco style pivot brackets 508h x 508w (618w incl. brackets)	\$2,420	\$2,620	\$2,365	\$2,790	\$2,960
	HH-MIRROR-RT-DECO	Rectangular tilting bathroom mirror with metal frame with Deco style pivot brackets 762h x 610w (720w incl. brackets)	\$2,835	\$3,070	\$2,770	\$3,290	\$3,495









Note: Basins, benchtops, tapware and bottletraps excluded from list price and sold separately.

This document supersedes all previous pricelists and is subject to change without notice. All pricing is in AUD Australian Dollars. RRP Pricing incl. GST. This pricelist is published & distributed by The English Tapware Company, Australia. E+OE. Prices issued on 13 May 2026. V038INTD-HH



DECO BATHROOM ACCESSORIES



STYLE	CODE	DESCRIPTION	PRICING IN EACH FINISH (INCL. GST)				
			CHROME / POLISHED BRASS/ SATIN BRASS	NICKEL	PEWTER	ANTIQUE BRASS/ BRONZE / GUN METAL	GOLD
			CP / BR / SB	NI	PF	AB / BZ / GM	IG
	HH-DECO-TOWELRING	HAWTHORN HILL - 190mm dia. Deco towel ring	\$410	\$450	\$410	\$495	\$530
	HH-DECO-ROBEHOOK	HAWTHORN HILL - Deco double robe hook	\$315	\$350	\$320	\$390	\$415
	HH-DECO-SHELF	HAWTHORN HILL - Deco glass shelf with guard rail 683mm centres, 751mm overall	\$775	\$850	\$775	\$945	\$1,010
	HH-DECO-TOWELRAIL	HAWTHORN HILL - Deco towel rail 452mm centres, 520mm overall	\$755	\$830	\$755	\$920	\$985
	HH-DECO-TUMBLER	HAWTHORN HILL - Deco wall-mounted porcelain tumbler	\$385	\$420	\$385	\$465	\$500
	HH-DECO-SOAPDISH	HAWTHORN HILL - Deco wall-mounted porcelain soap dish	\$370	\$400	\$365	\$445	\$480
	HH-DECO-PAPER	HAWTHORN HILL - Deco paper holder	\$410	\$450	\$410	\$495	\$530
	HH-DECO-WCBRUSH	HAWTHORN HILL - Deco wall-mounted toilet brush with porcelain brush holder	\$1,025	\$1,125	\$1,025	\$1,250	\$1,340

Note: Basins, benchtops, tapware and bottletraps excluded from list price and sold separately.

This document supersedes all previous pricelists and is subject to change without notice. All pricing is in NZD New Zealand Dollars. RRP Pricing incl. GST. This pricelist is published & distributed by In Residence, New Zealand. E+OE. Prices issued on 13 May 2026. V038INTD-HH



CUSTOM
ORDERING

Hawthorn Hill

Luxury Detailing

CUSTOM BASIN STAND ORDERING FORM

IDEAS:



SINGLE 2 LEG



DOUBLE 3 LEG



SINGLE 4 LEG



DOUBLE 6 LEG



SINGLE 2 LEG WITH SHELF



DOUBLE 3 LEG WITH SHELF



SINGLE 4 LEG WITH SHELF



DOUBLE 6 LEG WITH SHELF

1. SKETCH YOUR BASIN STAND CONFIGURATION HERE OR ATTACH A DRAWING:

*NOTE: SPECIFY IN CENTRE TO CENTRE MEASUREMENTS AND IN MILLIMETRES ONLY.

2. FILL IN CENTRE TO CENTRE DIMENSIONS*:

HEIGHT (H): _____MM

WIDTH (W): _____MM

DEPTH (D) _____MM

BASE RAIL FROM FFL (B): _____MM
(250MM UNLESS OTHERWISE SPECIFIED)

TOP RAIL FROM TOP (T): _____MM
(170MM UNLESS OTHERWISE SPECIFIED)

3. SELECT YOUR JOINT STYLE:

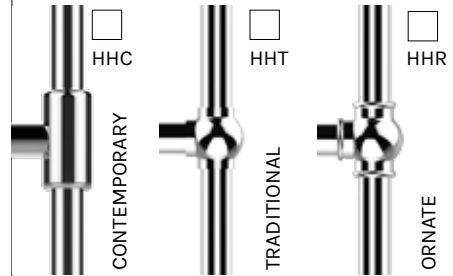

3. SELECT YOUR FOOT STYLE:

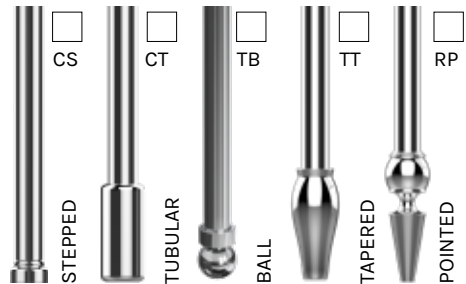

4. SELECT YOUR FINISH:



ADMIN ONLY

QUOTE NUMBER:

CLIENT NAME:

ORDER NUMBER:

CLIENT SIGNATURE:

PROJECT NAME:

CLIENT SIGN-OFF DATE:

____ / ____ / ____

PLEASE SUBMIT TO YOUR SALES CONSULTANT VIA EMAIL OR A PRINTED COPY

Hawthorn Hill

Luxury Detailing

CUSTOM MIRROR ORDERING FORM

NOTE: MINIMUM ORDER QUANTITY IS 20 FOR CUSTOM MIRRORS WITH ROUNDED PROFILES

1. CHOOSE YOUR STYLE:



CLASSICAL



DECO



FIXED

3. FILL IN YOUR FRAMED MIRROR DIMENSIONS, EXCLUDING MOUNTS*:

HEIGHT (H): _____MM

WIDTH (W): _____MM

NOTE: TILTING MOUNTS ADD APPROX 110MM TO THE OVERALL WIDTH

IDEAS:



RECTANGLE



ROUND



SQUARE



OVAL



RADIUS

4. SELECT YOUR FINISH:



CP

POLISHED
CHROME



NI

POLISHED
NICKEL



BR

POLISHED
BRASS



IG

GOLD



PF

BRUSHED
NICKEL



SB

SATIN
BRASS



AB

ANTIQUÉ
BRASS



BZ

BRONZE



GM

GUN
METAL

2. SKETCH YOUR MIRROR CONFIGURATION HERE OR ATTACH A DRAWING:

ADMIN ONLY

QUOTE NUMBER:

ORDER NUMBER:

PROJECT NAME:

CLIENT NAME:

CLIENT SIGNATURE:

CLIENT SIGN-OFF DATE:

____ / ____ / ____

*NOTE: ALL MIRRORS ARE MANUFACTURED USING CENTRE TO CENTRE DIMENSIONS. SPECIFY IN CENTRE TO CENTRE AND MILLIMETRES ONLY.

PLEASE SUBMIT TO YOUR SALES CONSULTANT VIA EMAIL OR A PRINTED COPY

1. CHOOSE YOUR WALL MOUNT:



2. CHOOSE YOUR JOINT STYLE:



IDEAS:

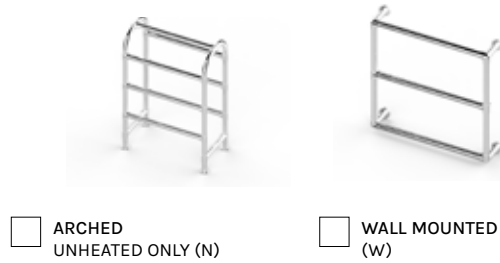

2. HEATING: ELECTRIC 240V NON-HEATED

3. SKETCH YOUR TOWEL WARMER CONFIGURATION HERE OR ATTACH A DRAWING:

PLEASE NOTE DUE TO MOVING TO TOP-LEVEL ELECTRICAL CERTIFICATION FOR OUR TOWEL WARMERS, WE CAN ONLY OFFER THE FOLLOWING BESPOKE OPTIONS:

- VARIABLE LENGTHS OF WALL MOUNT TUBES TO ACCOMMODATE DADO PANELS
- COMBINATIONS OF JOINT STYLE AND WALL MOUNT STYLE.
- ARCHED TOWEL RAILS ARE NOW ONLY AVAILABLE UNHEATED.

*NOTE: SPECIFY IN CENTRE TO CENTRE MEASUREMENTS AND IN MILLIMETRES ONLY.

4. FILL IN CENTRE TO CENTRE DIMENSIONS*:

HEIGHT (H): _____MM
 WIDTH (W): _____MM
 DEPTH (D) _____MM
 (138MM UNLESS OTHERWISE SPECIFIED)
 BASE RAIL FROM FFL (B): _____MM
 (MUST BE 625MM OR MORE FOR FLOOR MOUNTED DESIGNS)
 NUMBER OF HORIZONTAL RAILS: _____

5. SELECT YOUR FINISH:



ADMIN ONLY

QUOTE NUMBER:

ORDER NUMBER:

PROJECT NAME:

CLIENT NAME:

CLIENT SIGNATURE:

CLIENT SIGN-OFF DATE:
 ____ / ____ / ____



INSTALLATION
GUIDES

FIXED WALL MIRRORS INSTALLER'S GUIDE

STEP BY STEP FIXED WALL MIRROR INSTALLER'S GUIDE

Sophisticated edges, quality UK engineering and a range of styles make our latest offering of Hawthorn Hill mirrors a superior choice.

The fixed mirrors are framed in brass, and are designed to be flush-mounted on the wall in either portrait or landscape orientation.

BEFORE YOU BEGIN

STEP 1: INSPECT THE MIRROR

Unpack the mirror carefully and remove it from its box. Remove the packaging from the mirror and ensure it is the model and size you require for this installation. Check the mirror for any sign of damage. If it is not the correct mirror or there is any sign of damage, do not install it but re-fit the packaging and return it to the box. Then immediately contact the company who supplied the mirror and advise them of the problem.

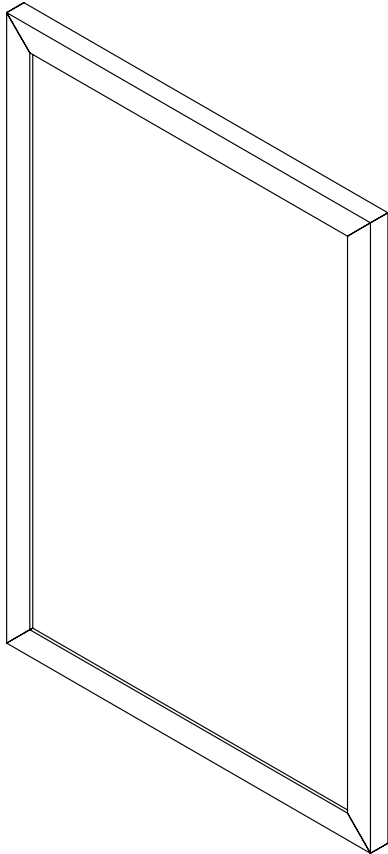

TOOLS YOU'LL NEED

- Fixings Kit (in envelope)
- Screw driver
- Spirit Level

STEP 3: PREPARING THE ROOM

Ensure the wall construction is appropriate to support the mirror. Ask your client at what height they would like the mirror installed. We recommend the centre of mirror at 1650mm off FFL.

STEP 4: INSTALLATION

Supplied with the mirror is a fixing strip, which will be mounted to the wall first.

1. Place the wall fixing strip against wall in the desired position, making sure it is level and the slots are facing the wall.
2. Secure to wall. Use of fixing plugs to receive the screws will be required for tiles or stone.

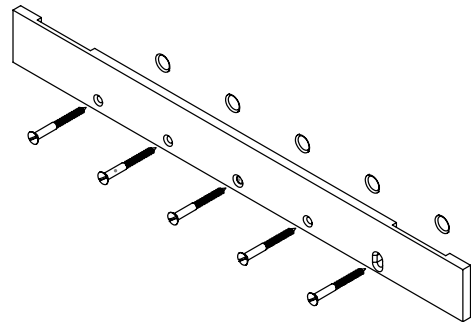

3. Slide Frame on to Wall Bracket lining up the tabs on the back of the mirror with the slots in the wall fixing. Mirror can be hung portrait or landscape.

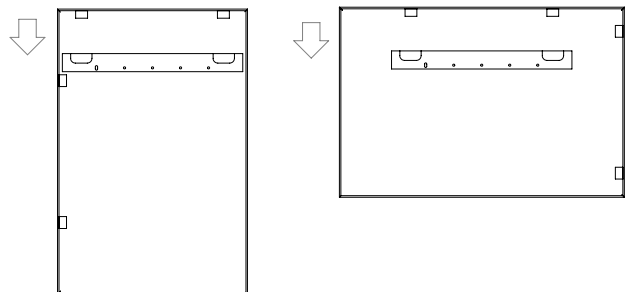

STEP 5: You're done!

Please tag @hawthorn_hill #hawthornhill on instagram to share your great work.

TILTING WALL MIRRORS INSTALLER'S GUIDE

STEP BY STEP TILTING WALL MIRROR INSTALLER'S GUIDE

Sophisticated edges, quality UK engineering and a range of styles make our latest offering of Hawthorn Hill mirrors a superior choice.

The tilting mirrors are framed in brass, and are designed to be mounted on the wall using concealed fixings.

BEFORE YOU BEGIN

STEP 1: INSPECT THE MIRROR

Unpack the mirror carefully and remove it from its box. Remove the packaging from the mirror and ensure it is the model and size you require for this installation. Check the mirror for any sign of damage. If it is not the correct mirror or there is any sign of damage, do not install it but re-fit the packaging and return it to the box. Then immediately contact the company who supplied the mirror and advise them of the problem.

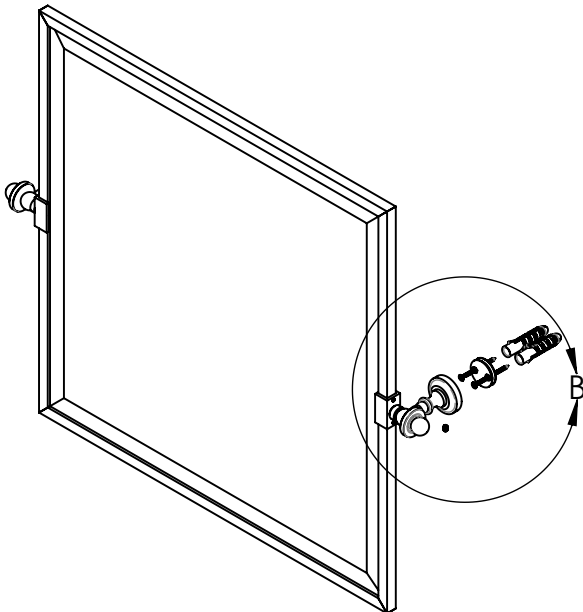

TOOLS YOU'LL NEED

- Fixings Kit (in envelope)
- Screw driver
- Spirit Level
- Allen key
- Assistant to hold the mirror in place
- Tape measure
- Masking tape

STEP 2: PREPARING THE ROOM

Ensure the wall construction is appropriate to support the mirror. Ask your client at what height they would like the mirror installed. We recommend the centre of mirror at 1650mm off FFL.

STEP 3: INSTALLATION

1. Measure and mark out your desired height or use our recommended 1650mm bracket height.
2. Supplied with the mirror are two concealed fixing mounts. These have a groove that will receive the grub screw. Position these mounts at the required height and spacing of the mirror brackets. Note: use of fixing plugs

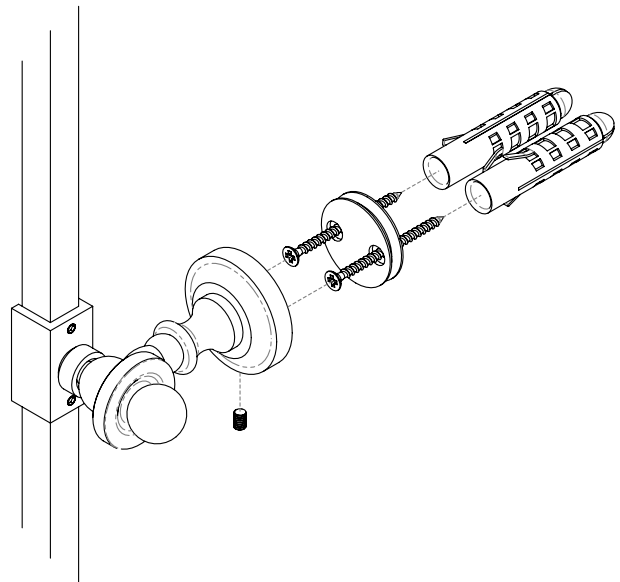

to receive the screws will be required for tiles or stone.

4. Ensure that the fixing mounts are secured to the wall. Call over your assistant to hold the mirror in place with the GRUB SCREW HOLES FACING TO THE CEILING. Use the allen key to tighten up the grub screws on top.

Before your assistant holding the mirror lets it go, double check that your grub screws are holding the mounts into position. If not, undo the grub screw and re-position to find the groove in the concealed plate.

STEP 4: You're done!

Please tag @hawthorn_hill #hawthornhill on instagram to share your great work.

Hawthorn Hill

Luxury Detailing

BASIN STAND INSTALLER'S GUIDE

GUIDE TO HAWTHORN HILL BASIN STANDS

Hawthorn Hill basin stands are designed to sit directly under and support handbasins or to support a flat vanity top with an inset or vessel basin. They can have a shelf below for storage and the top bar is an ideal hand-towel rail. There are standard sizes for Perrin & Rowe and The Water Monopoly handbasins and they can be custom made to any size to perfectly complete a bathroom project.

INSTALLATION

TOOLS YOU'LL NEED

- Fixings Kit (small package inside box)
- Soft towel or blanket
- Screw driver
- Spirit Level
- Drill
- Masking tape
- Basin or benchtop
- Support angle (sold separately)

PREPARATION FOR INSTALLATION

Prior to the wall linings being fitted, the builder needs to ensure there is solid material behind each wall mounting disc for secure fixing of each wall mount. The plumber needs to ensure the hot and cold water supplies come out of the wall in the correct position and that the waste pipe is in the correct position through the wall or floor for connection of the waste trap.

INSTALLATION

STEP 1: INSPECT THE BASIN STAND

Unpack the basin stand and carefully remove it from its box. Remove the packaging and ensure it is the model and size you require for this installation. Check the basin stand for any sign of damage. If it is not the correct basin stand or there is any sign of damage, immediately contact the person or company who supplied the basin stand and advise them of the problem.

STEP 2. ASSEMBLY

Hawthorn Hill basin stands require some assembly on site. Assemble the basin stand on the soft towel or blanket to avoid damaging the finish.

Align the labelled joints with the appropriate pieces and tighten the grub screws in place.

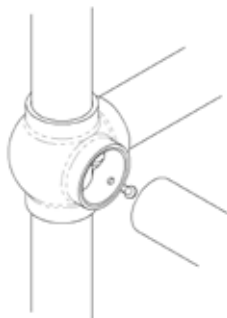

STEP 3. POSITIONING

Place the stand in its intended position against the wall. Ensure the wall construction is appropriate to support the basin stand and that the specifier has allowed for any slope in the bathroom floor. Some feet and the top caps unscrew to allow for a small variation.

Check the plumber has correctly positioned the water inlets and waste outlet.

STEP 4. FIXING WALL MOUNTS

Our basin stands are made with concealed fix wall flanges. These mounts have a hidden brass wall mounting disc fixed to wall with a single central screw.

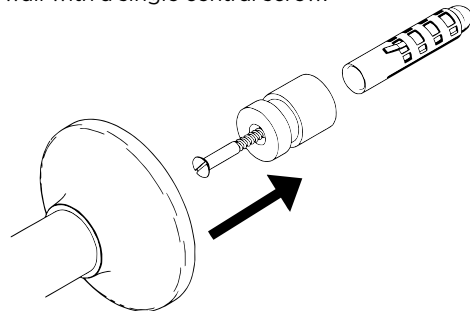

Each wall mount has a concealed mounting disc which is secured onto the wall using a central screw. Fix these discs in their required position on the wall. Push the basin stand arms over the discs and back against the wall. Check the basin stand for plumb and level.

STEP 5. FIXING FEET PINS

Each foot (except the ball foot) will have a threaded hole into which the installer can screw the provided pins. This enables them to drill a hole in the floor to insert the pin and hold the foot in position. If required, basin stand can be custom manufactured to accommodate drastic slope in floor.

If using the feet pins into the floor, locate their position with masking-tape on the floor, remove the stand from the wall, screw the pins into the feet, drill the locating holes into the floor. Refit the stand on the wall mounts with the pins into the floor holes and secure it by tightening the grub-screws onto the mounting discs.

STEP 6: INSTALLATION OF A HANDBASIN

Make two timber supports to sit against the wall and support the rear of the basin when the front is supported on the basin stand. Level the basin and when it is sitting in the desired position, secure the basin to the wall, remove the timber supports and leave ready for the plumber to fit the taps and waste.

BASIN STAND INSTALLER'S GUIDE

INSTALLATION OF A VANITY TOP

When a basin stand is supporting a vanity top, liaise with the company supplying the top to see what support it needs for the top to span between the top of the basin stand legs and the wall.

Where a top can be self-supporting between the basin stand legs, Hawthorn Hill offer 32 x 32m angle supports in 520mm and 1040mm lengths sold separately. Made of brass and finished to match the basin stand, this is screwed to the wall level with the top of the basin stand legs to support the rear of the top which can be fixed to it with a few dabs of silicone.

ANGLE SUPPORT OPTION

Where a vanity top can be self-supporting between the basin stand legs Hawthorn Hill offer a support angle in the following sizes (sold separately):

- Single 32 x 32 x 520mm (HH-ANGLE-520)
- Double 32 x 32 x 1040mm (HH-ANGLE-1040)

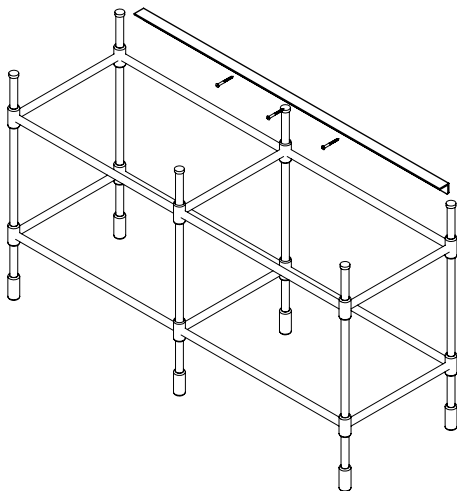

STEEL FRAME OPTION

Another solution is to have an engineer make a rectangular steel frame using 25mm angle-iron which sits on the inside face of the basin stand legs and fixes to the rear wall. The top sits on this frame and can be held in position on it with a few dabs of silicone.

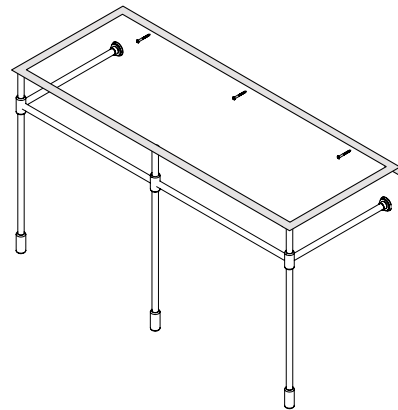

A small frame can be made using flat steel with an angle steel on rear edge. To work out the dimensions of the frame:

- calculate the overall width left to right of your basin stand from outside edge of the top tube to outside edge of top tube.
- calculate the distance off your basin stand from the wall to the front outside edge of the top tube. This becomes the depth of your frame.
- to fix to the wall you will need an angle at the rear of your stand that is 25mm. Ensure the engineer drills fixing holes along the back edge. Arrange for powdercoating in desired colour.

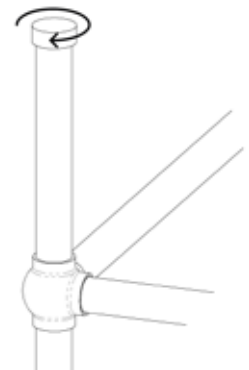

STEP 7: FINE ADJUSTMENT

Hawthorn Hill basins stands offer fine adjustment in the top hat of each leg. Rotate these top hats to perfect the positioning of the basin or vanity top.

STEP 8: You're done!

Please tag @hawthorn_hill #hawthornhill on instagram to share your great work.

GUIDE TO PURCHASING AND INSTALLING HAWTHORN HILL ELECTRIC TOWEL WARMERS

Hawthorn Hill towel warmers are designed for drying towels and small items of clothing. While they are not intended to be room heaters, they can contribute to the warming of bathrooms and laundries.

FINISHES

They are made from 32mm brass tube and available in the following finishes. Polished Brass (BR), Brushed or Satin Brass (SB), Polished Chrome (CP), Polished Nickel (NI), Brushed or Satin Nickel (PF), Gold plating (IG), Aged Brass (AB), Bronze which is a dark brown (BZ), and Gunmetal which is nearly black (GM).

ELECTRICAL RATING

Hawthorn Hill electrically heated towel warmers are supplied complete and ready to install. They contain an electrical heating cable to provide an even heat over the full surface area.

All models are supplied with a six-metre long electrical cable, are 240V and IP55 rated. Please pass this information on to your Electrician and advise him of the location of the towel warmer in your bathroom.

CABLE POSITION

The standard position for the element cable is through the rear of the wall bracket in the top right corner. The option of the electrical cable coming through the rear of other brackets is available by specifying this at the time of ordering.

PREPARATION FOR INSTALLATION

Prior to the wall linings being fitted, the Builder needs to ensure there is solid material behind each corner of the towel warmer for secure fixing of each wall bracket. The Electrician needs to run an electrical conduit (PVC pipe) within the wall to run the cable to the switch for the towel warmer. This switch may be in an adjoining room. A draw-wire is left within the conduit so that when the towel warmer is eventually fitted, the Electrician can pull the element cable through the conduit and connect it to the electrical supply in the switch.

STEP 1: INSPECT THE TOWEL WARMER

Unpack the towel warmer carefully and remove it from its box. Remove the packaging from the towel warmer and ensure it is the model, size and heating element position you require for this installation. Check the towel warmer for any sign of damage. If it is not the correct towel warmer or there is any sign of damage, do not install it but re-fit the packaging and return it to the box. Then immediately contact the person or company who supplied the towel warmer and advise them of the problem.

STEP 2. A LICENCED INSTALLER

Installation should only be conducted by a Registered Electrician. It must be installed in accordance with the relevant electrical wiring rules and regulations, and particularly those regulations which cover installation of appliances and accessories in damp situations such as bathrooms and laundries.

PLEASE NOTE:

Standard AS/NZS 60335.2.43:2018 requires the installation instructions for fixed towel warmers to include the following warning. In order to avoid a hazard for very young children, this appliance should be installed so that the lowest heated rail is at least 600 mm above the floor. This appliance is not intended for use by young children or infirm persons unless they have been adequately supervised by a responsible person to ensure that they can use the appliance safely.

Young children should be supervised to ensure that they do not play on the appliance.

STEP 3: CHECK THE PREPARATION

Ensure the wall construction is appropriate to support the towel warmer. Ensure the Electrician has run a conduit with a draw-wire to the electrical switch.

STEP 4: INSTALLATION

Hawthorn Hill towel warmers are made with concealed fix 75mm dia. wall and floor flanges on Traditional (HHT) and Ornate (HHR) models and 60mm dia. on the Contemporary models (HHC).

Each towel warmer has four brass mounting discs which are secured onto the wall using single central screws. The heating element cable exits the towel warmer through one of these discs. Once the installer is confident the brass mounting discs are in their correct positions, the element cable is drawn through the conduit as the towel warmer is mounted over these four discs. Once sitting correctly back against the wall, secure it by tightening the grub-screws onto the mounting discs. Connect the heating cable.

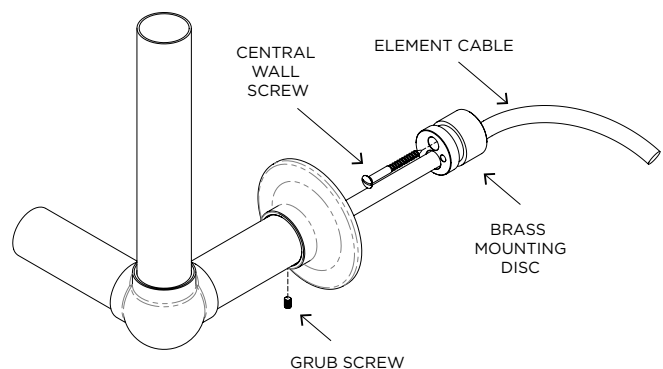

STEP 5: CONTINUOUS USAGE

The Hawthorn Hill electric towel warmer has a low wattage element which can be left on continuously without detrimental effect either to the towel warmer or to the articles on it.

STEP 6: INSTALLATION COMPLETE Congratulations on a job well done! Please tag @hawthorn_hill #hawthornhill on instagram to share your great work.

BATH STAND ASSEMBLY GUIDE

STEP BY STEP BATH STAND ASSEMBLY GUIDE

Hawthorn Hill bath stands are a luxury accessories, designed and manufactured in the UK by craftsmen. The 19mm tubular legs are turned on a lathe, and then finished in one of their signature finishes. Each shelf is premium toughened glass.

BEFORE YOU BEGIN

STEP 1: INSPECT THE BATH STAND

Take all necessary precautions to ensure that this product is protected during assembly. We recommend you unpack and assemble this bath stand on a clean, soft surface such as a bath towel or blanket.

Unpack the bath stand carefully and remove it from its box. Remove the packaging from the glass and brass pieces and ensure it is the model and size you require for this installation. Check the bath stand pieces for any sign of damage. If it is not the correct bath stand or there is any sign of damage, do not install it but re-fit the packaging and return it to the box. Then immediately contact the company who supplied the bath stand and advise them of the problem.

STEP 2: PREPARING THE ROOM

Ensure you know where your client would like this bath stand positioned. The feet are adjustable to accommodate uneven tiled floors. Remember this is a luxury item. Please do not place tools or heavy objects on the shelves.

TOOLS YOU'LL NEED

- Soft towel or blanket
- Spirit Level

PARTS PROVIDED:

- A - 4 x Top Rails
- B - 4 x Corner Ball Connectors
- C - 4 x Top Collar
- D - 3 x Glass Shelf
- E - 8 x Long Tubes
- F - 4 x Short Tubes
- G - 4 x Feet

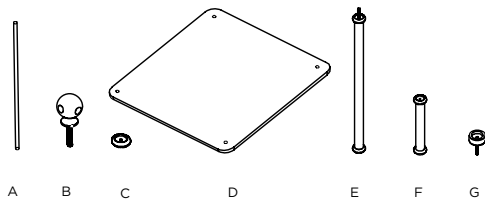

STEP 3: ASSEMBLY

This bath stand comes from UK flat-packed for assembly to avoid breakages in transit.

Assembly on site is simple.

1. Lay the parts on a protective sheet for assembly to minimise any damage to the surface finish (the Bathstand is assembled up-side-down for ease, starting at the top)

2. Push the round Top Rails (A) into the Corner Ball Connections (B) to make a square / rectangle. (Note; there is no fixing for these Top Rails)

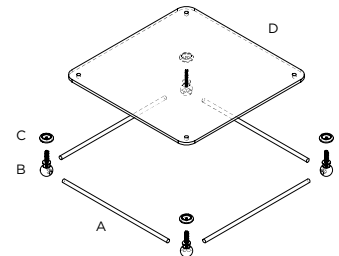

3. Put the Top Collar (C) onto the thread in the Corner Ball with Rubber Gasket facing upwards (facing glass)

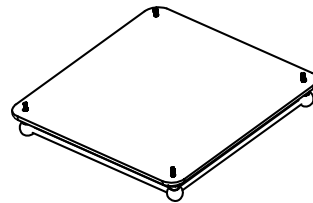

4. To secure these parts in place, position Glass (D) over the 4 x Threads exposed through the glass.

5. Take 4 x Long Tubes (E) and screw them onto the exposed threads. DO NOT TIGHTEN AT THIS STAGE.

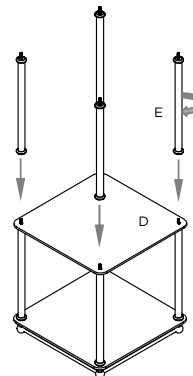
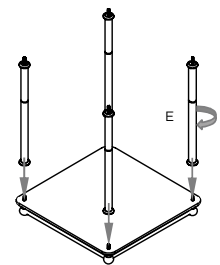

6. Once they are fixed in place, place the second Glass Shelf (D) on to the exposed threads.

Hawthorn Hill

Luxury Detailing

NEW ZEALAND:

In Residence

219 Great South Road,
Greenlane, Auckland 1051

Email: sales@inres.co.nz

Telephone: 09 309 3023

WWW.INRES.CO.NZ